



Kabuto
Japan

EXCEED



Instruction Manual

BEFORE USE

**PRIOR TO USE, READ THIS INSTRUCTION
MANUAL THOROUGHLY AND KEEP THIS
FOR FUTURE REFERENCE**

EXCEED

Instruction Manual • Table of Contents

EXCEED Instruction manual • Table of Contents P-2

Part Description P-3

For Safe and Comfortable Use

NOTES BEFORE USE P-4

Chinstraps

1 Removing and Replacing the Chinstrap Covers P-6

2 Fastening and Unfastening the Chinstraps P-7

Air Ventilation Functions

3 [Ventilation System] and [Wake Stabilizer PATENTED] P-8

4 Operation of Ventilations and Shutter Functions P-9

Shield

5 [Single Action Shield System PATENTED] P-10

6 Removing and Replacing the Shield Ratchets P-12

7 [Optional Parts] Pinlock® Original Insert Lens P-14

8 Opening and Closing the Inner Sunshade P-16

9 Removing and Replacing the Inner Sunshade P-18

Interior (Inner pad, and Cheek pad set)

10 Removing and Replacing the Cheek Pad set P-19

Reference Ear Cup P-20

Reference Intercom System Attachment Space P-20

11 Removing and Replacing the Inner Pad P-21

Reference Compatibility of the Inner Pad and the Cheek Pad set P-22

IMPORTANT Notes about Cleaning Interiors (Inner Pad, Cheek Pad set, and Chinstrap Covers) P-23

Reference Functional Materials Adopted on EXCEED P-23

Replacement Parts List • Repair • Contact

Replacement Parts List and Correspondence Repair Table P-24

Contact for Inquiries and Request for Repair

EXCEED

Part Descriptions



NOTES BEFORE USE

Thank you very much for purchasing the Kabuto helmet.

This Instruction Manual describes proper handling, various functions, and removal and replacement of each part of this helmet. Please read this Instruction Manual thoroughly prior to use.

After reading this, keep the Manual for future reference.

The helmet is just an element of protection, intended to minimize the risk in the event of an accident. It cannot ensure complete safety. Use this helmet properly with understanding this point very well.

Please understand and follow the instructions and information in this Instruction Manual to enjoy your pleasant and safe motorcycle ride.

Select the proper size!

It is very dangerous to wear too large size of the helmet. This may wobble while riding on a motorcycle. If you wear too small size helmet, it tightens up and hurts your head. Thus, it is important to select the helmet size that fits you.

Fasten the chinstraps before riding

The helmet is designed to be retained by straps under the chin. In order to assure proper protection, the helmet should fit your head. When worn, adjust it to rest properly on the head, securely fasten the chinstraps to ensure safety. The chinstraps prevent the helmet from coming off in most cases.

Never use the helmet once impacted

Liners are essential for the intended performance of the helmet. This helmet has been designed to absorb the impact energy when components such as shell and liners are partially destroyed by an impact. Even if visually no damage is apparent, it could be seriously damaged by a small impact. Regardless of the degree of damage, the helmet that underwent an impact or was abused even only once should not be used anymore. Always handle the helmet with care and make sure that no one sits on it or drops it.

Never remodel the helmet

In order to fully maintain the performance of this helmet, do not attempt to take it apart or change it in any manner such as making holes in it, or cutting it (or any of its parts).

Helmet care and cleaning

To clean the helmet, use common pH-neutral detergent diluted with clear water. The cloth should not be soaking wet, then wipe it gently with dry cloth. Finally wipe away the detergent solution by using a cloth rinsed in clear water, and leave the helmet to completely dry, but not in direct sunlight. With regard to helmets with removable interiors, carefully read the instruction manual for that model before attempting to remove the interiors and carry out cleaning according to the explanation provided.

To clean the helmet do not use saline water or hot water (above 50°C).

Do not paint or apply solvent

Any paint, glue, adhesive stickers, etc. (or the use of detergents and solvents other than those prescribed) may not only reduce the original protective performance of the helmet considerably, but may also cause damage to the helmet that cannot be detected by the naked eye.

Handle your helmet with care

Do not toss your helmet over a floor or sit on it. The helmet absorbs an impact every time it is handled roughly and its impact-absorbing capacity will be decreased. Handle your helmet with care so as to assure its full intended function in the event of an accident.

Do not use your helmet for any purpose other than to use for protecting your head while riding.

The storage of the helmet

After using the helmet, stow it away in the helmet bag and store on a level place such as a shelf; the helmet may be damaged if it rolls around or falls down. Do not leave the helmet in direct heat above 50°C e.g. next to a heater or under direct sunlight in a car.

Shield care and cleaning

After using your helmet, with a wet soft cloth, lightly wipe off any grime (e.g. dead insects, dirt, sand, dust, etc.) on the shield and then fully wipe it clean using a dry soft cloth. When the shield gets wet (e.g. rainwater), it should always be wiped with a soft cloth after use. When cleaning the shield, never use any petroleum-based solvents or detergents containing abrasives.

Contact with petroleum products and other solvents may impair the optical properties and reduce the mechanical strength.

To clean the shield, apply some common ph-neutral detergent diluted with clear water using a soft cloth and wipe gently. Finally, wipe it dry with a lint-free soft cloth. To clean the shield, do not use saline water or hot water (above 50°C).

Cautions for shield

If the shield is marked “Day Time Use Only”, visibility is limited to daylight conditions and it is not suitable for use at night. Tinted lenses are not suitable for use at night.

A shield and goggles with scratches lowers the visibility and this is very dangerous. Such shields should never be used at night and should be replaced.

Contact with petroleum products and other solvents may impair the optical properties and weaken the strength of the shield. Never try to open and close or to remove the shield while riding.

Notes for use of full-face helmet

When you wear a full-face helmet, the temperature in the helmet is maintained nearly constant during riding but the surroundings are constantly changing since you are moving at a high speed. For this reason, in case of sudden rain, immediately after entering a tunnel or in a place with a large difference in height such as a mountain path cause difference in temperature between inside and outside of the helmet. As a result, the shield of the helmet may be fogged suddenly. In case such a risk is expected, please use caution with adjusting the shield or slowing down your speed in advance. Never open and close the shield or adjust the ventilation shutter while riding since it is very dangerous. Thus, operate them before riding.

1 Removing and Replacing the Chinstrap Covers

Chinstrap covers are available to wash by detaching them from the chinstraps.

–Removing–

1. Undo the hook-and-loop fastener at the end of each chinstrap.
2. Pull the chinstrap cover from the chinstrap body to remove it.

–Attaching–

1. In the reverse order of removing, (pay attention to the direction of the chinstrap cover), let the chinstrap go into from the upper portion of the chinstrap cover, and let the end of the chinstrap out from the hole on the chinstrap cover.
2. Finally, fasten the hook-and-loop fastener.

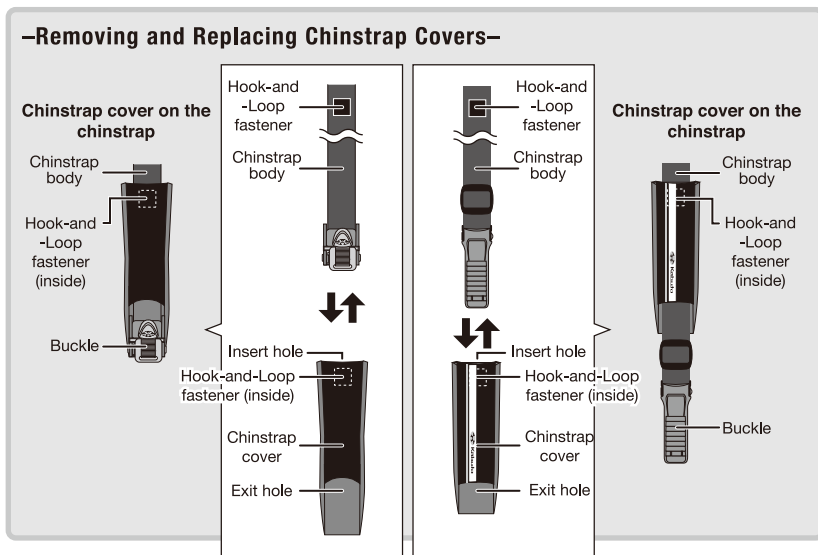

⚠ CAUTION!

Please be aware about the sides of the chinstrap covers.
Front face is synthetic leather.
Back face is the side chin touches.

2 Fastening and Unfastening the Chinstrap

This helmet adopts the “Micro-Ratchet-Buckle” for easy fastening and unfastening the chinstraps.

–Fastening the Chinstrap–

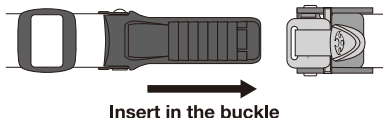

–Unfastening the Buckle–

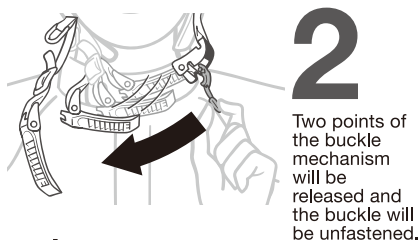
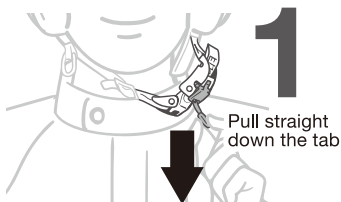

! WARNING!

Be sure to fasten the chinstrap securely.

Otherwise, in case of falling down or an accident while riding, the helmet may come off, and may cause serious injuries.

Adjusting the Chinstrap Length

–Proper Chinstrap Length–

Wear the helmet and fasten the buckle tight. The proper chinstrap length would allow your forefinger to slip in between the chinstraps and your neck. If the length is not proper, please adjust the length of the chinstraps.

<Side View>

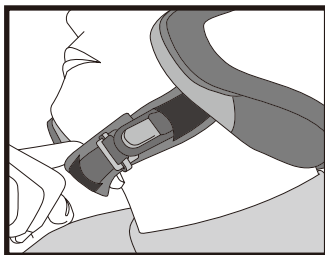
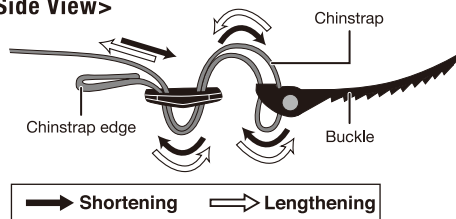

! WARNING!

Be sure to adjust the length of the chinstraps of the helmet properly.

Otherwise, your helmet may drop off or choke your neck in case of an accident while riding. Chinstraps play a very important role. Thus, please adjust the chinstraps of your helmet properly and securely before riding.

3 [Ventilation System] and [Wake Stabilizer^{PATENTED}]



[Ventilation System]

The ventilation system effectively takes outer air in and pushes the inner humid air out by the air pressure from the front while riding. The ventilations are equipped with a shutter which prevents cold air and water drops from coming into the helmet.

<Ventilation Structure>

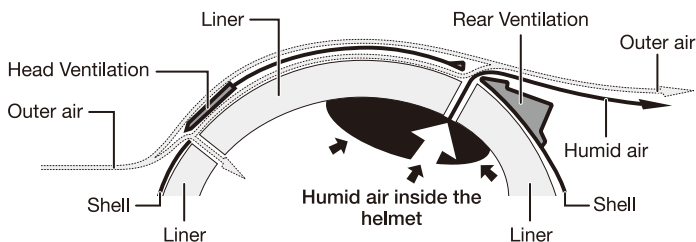

[Wake Stabilizer^{PATENTED}]

Kabuto's unique patented aerodynamic device; **Wake Stabilizer^{PATENTED}**; is developed by analyzing the results of wind tunnel experiments at several angles. This unique system controls the airflow around the helmet and reduces loads while riding.

*Patent No. 4311691

4 Operation of Ventilations and Shutter Functions

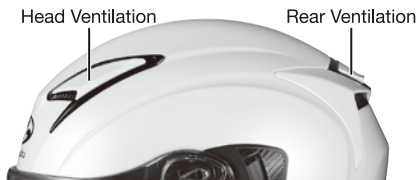

-Open/Close the Head Ventilation-

To Open

Slide the shutter backward, and the air duct is opened to take in air.

To Close

Slide the shutter forward, and the air duct is closed to shut off air intake.

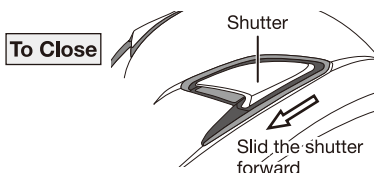
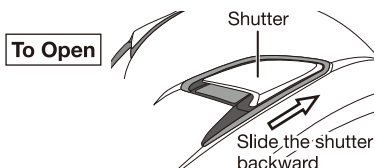

-Open/Close the Rear Ventilation-

To Open

Slide the shutter backward, and the air duct is opened to discharge the hot air inside the helmet.

To Close

Slide the shutter forward to close. Air duct will be shut, and break the air discharge.

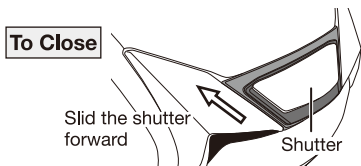
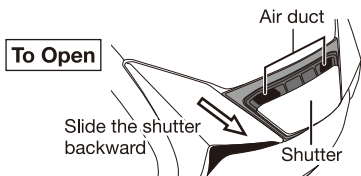

! CAUTION!

Do not put strong pressure on the ventilations.
Make sure to treat them with care.

*Please read the "WARNING" and "Repairing the ventilations" on the next page.

⚠ WARNING!

- Operating the shutter or the cover of the ventilations while riding on a motorcycle is very dangerous. Never operate them while riding. Operate it before riding or after stopped in a safe place.
- The air-ducts (air intakes and discharge holes) of the ventilations are designed in the optimal sizes and quantities in consideration of a large impact in the event of accident and falling down. Customizing by enlarging or making more air-ducts would reduce the safety performances greatly and can cause serious injuries in case of an accident. Never customize your helmet.

❗ Repairing the Ventilations

When each ventilation is damaged, it should be repaired by the manufacturer (See Pages 23 to 25). Please be informed that we may not accept repairing, in the case the safety performance of the helmet will be degraded.

5 Single Action Shield System^{PATENTED}

The “Single Action Shield System^{PATENTED}” is the shield replacement system developed by Kabuto. The system allows quick shield replacement and easy maintenance.

–How to remove the shield–

- ① Move the shield up to the top (Fig. 1). (Move it up as far as it goes.)
- ② As shown in Fig. 2, pull the shield in the sense of the arrow while pressing down the release button on the shield. One side of the shield is completely removed.

*The shield can be removed easily by pulling it along the angle of the end of release button.

- ③ Repeat the same procedure for removing the other side of the shield. Then the entire shield can be completely removed.

❗ CAUTION!

- The shield is so constructed that it cannot be removed unless it is moved up to the highest position.
- Do not pull or twist the shield by force to remove it. Such action may damage the shield and ratchet system.
- Handle the removed shield with care so as not to damage it.

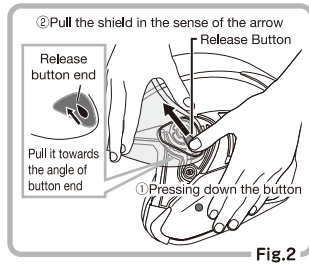
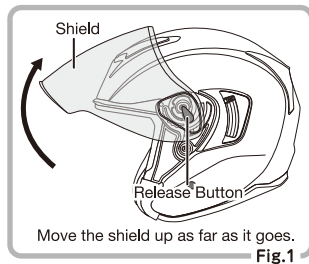

-How to attach the shield-

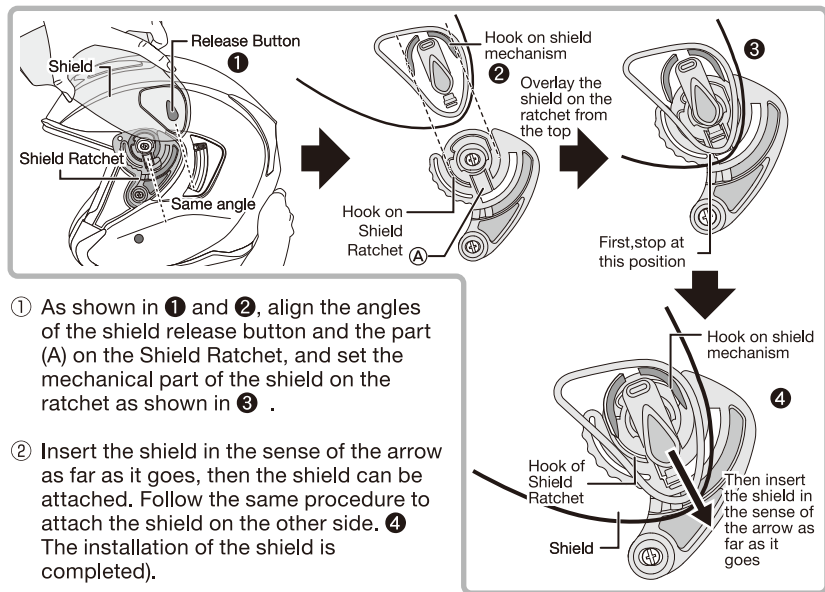

❗ CAUTION!

- Do not push or twist the shield by force when installing it. Such action may damage the shield and ratchet system.
- After the installation of the shield is completed, be sure to pull it lightly towards the removing direction to make sure that it is securely installed.
- After the installation of the shield is completed, open and close the shield three to four times to make sure that the shield works properly.

⚠ WARNING!

- After the installation of the shield is completed, make sure that the shield is securely installed and that it properly opens and closes before riding the motorcycle. If the shield does not work properly, or is installed insecurely, it may cause a failure in opening and closing operation of the shield or lead to the removal of the shield while riding, thereby causing a great risk. If the opening and closing operations are not properly performed or abnormal noise is heard during these operations, check the steps in the installation procedure and repeat the installation procedure from the start.
- The shield is a consumable item. If the shield surface is damaged by a bug, stone, etc., it may hinder the vision, thereby causing a great risk. If the shield gets extremely dirty or scratched, replace it with a new one.

6 Removing and Replacing the Shield Ratchets

The “Shield Ratchet” is a part to control the opening and closing of the shield and the function of the “Single Action Shield System PATENTED”.

When the shield is completely removed in the procedure mentioned in 5 “Single Action Shield System PATENTED”, the Shield Ratchet appears.

–How to remove the Shield Ratchet–

Turn the Shield Ratchet Screws on the Shield Ratchet counterclockwise using a proper size screwdriver to unscrew. Then, the shield ratchet can be removed. Follow the same procedure to remove the Shield Ratchet on the other side.

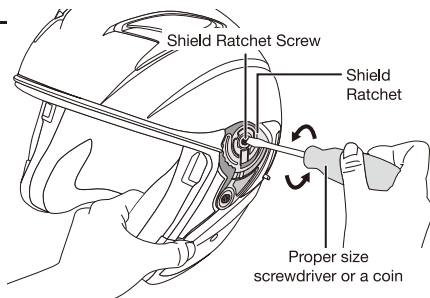

! CAUTION!

- Use the proper size screwdriver to remove the Shield Ratchet Screws. Turn the screw by applying the screwdriver vertically to the screw. If the improper size screwdriver is used or the screw is turned diagonally, the threads may be stripped.
- Do not lose the removed screws.
- Anti-loosen coating is treated on the screws. Once the coating is peeling off, do not keep using the screw. Replace them to the new one.

–How to install the Shield Ratchet–

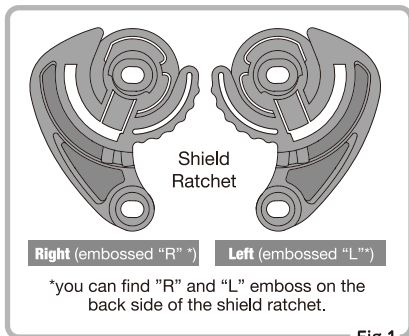

- ① First, check the side of the Shield Ratchet as shown in Fig.1.

! Check before installation

For EXCEED series, make sure to use the one with “N” embossed on the back side of the shield ratchet.

“N” emboss on the back side

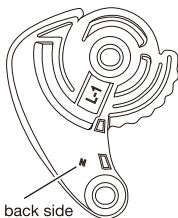

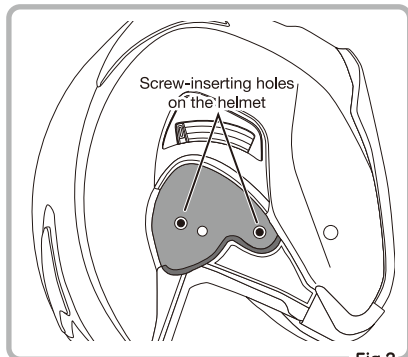

Fig.2

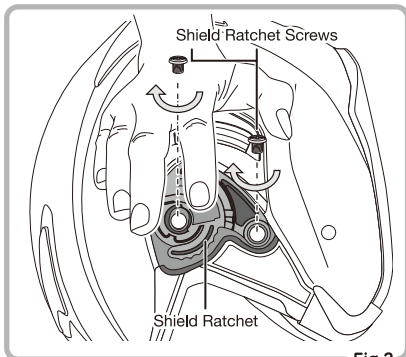

Fig.3

- ② Place the Shield Ratchet in the recess on the side of the helmet and align the mounting holes on the shield ratchet with the mounting holes on the helmet (Fig. 2).
- ③ Fasten each Shield Ratchet Screw clockwise securely. Repeat the same procedure on the Shield Ratchet on the other side of the helmet. Then the installation of the shield ratchets is complete (Fig. 3).

⚠ CAUTION!

- Do not fasten the Shield Ratchet Screws too tight more than needed. Too much tightening of the screws may damage screws and other parts.
- Fasten the Shield Ratchet Screws by applying the screwdriver vertically to the screws. If the screws are fastened by applying a screwdriver diagonally, the threads may be stripped.

⚠ WARNING!

- The Shield Ratchet is an important part for opening and closing of the shield. Install the Shield Ratchet securely. After the installation is completed, check to see that the shield can be closed to the lowest position and opened and closed correctly.
- Check and fasten the Shield Ratchet Screws regularly. Riding with the loosened Shield Ratchet Screws is very dangerous as the shield may be removed while riding.
- Anti-loosen coating is treated on the screws. Once the coating is peeling off, do not keep using the screw. Replace them to the new one.

7 Optional Parts

Pinlock® Original Insert Lens has international patent protection and is a registered brand name of Pinlock® fog-free systems B.V. Further patents have been applied for.

PINLOCK®

Original Insert Lens

MAX^{100%}

VISION

Pinlock® Original Insert Lens is the effective anti-fog sheet. The shield of your helmet is equipped with the Pinlock® pins (eccentric pins) which allows the exclusive Pinlock® Original Insert Lens to be attached to it. The Pinlock® Original Insert Lens is available to purchase at the dealers.

Pinlock® Original Insert Lens

For SAJ-P

Pinlock® Original Insert Lens prevents the shield from fogging caused by thermal changes in winter or rainy weather etc.

Maintaining the proper space between the shield and the Pinlock® Original Insert Lens provides clear vision by balancing the inner and outer temperature.

Attaching / Detaching the Pinlock® Original Insert Lens

–How to Attach the Pinlock® Original Insert Lens–

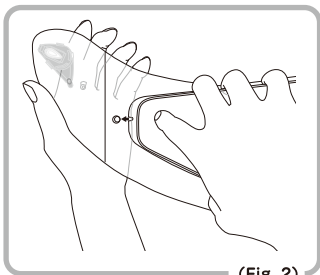
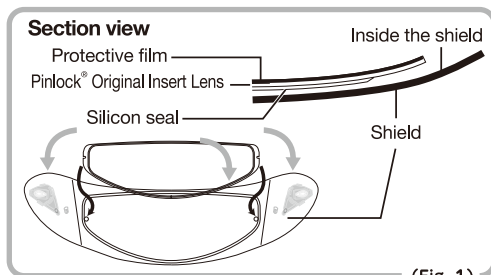

- ① Apply the silicon seal side of the Pinlock® Original Insert Lens on inside the shield, without peeling off the protective film on the lens. At the time, apply the Pinlock® Original Insert Lens on inside the shield by clicking it into the eccentric pins. (Fig 1 and 2)

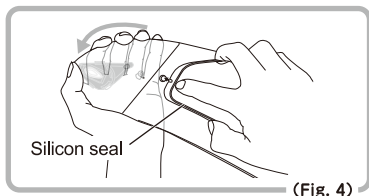
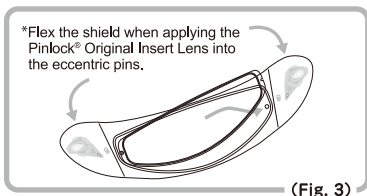

- ② Flex the shield carefully until the shield becomes flat. Then, click the other side of the Pinlock® Original Insert Lens into the eccentric pins and then allow the shield to return carefully to its original curved shape. (Fig. 3,4,5)

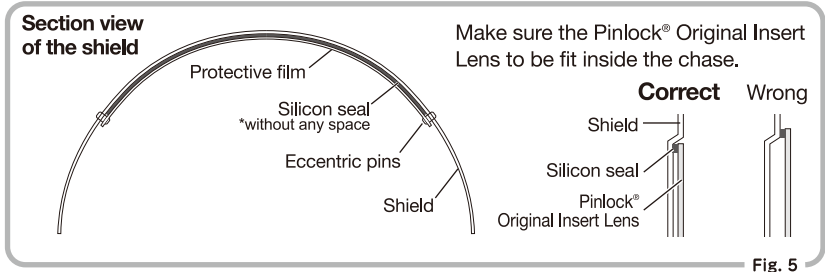

Fig. 5

- Make sure if the overall silicon seal of the Pinlock® Original Insert Lens is attached firmly to the shield by mounting the shield on the helmet. If there is any space between them, refer to “How to Adjust Pinlock® Original Insert Lens after Attachment” and adjust the lens.

*Please mount the shield on the helmet when checking if the Pinlock® Original Insert Lens is attached firmly to the shield. Otherwise, the shield might be spread out by the pressure from the lens and it cannot be assured if the lens has attached on the shield firmly.

- Peel off the protective film on the Pinlock® Original Insert Lens.

-Detaching Pinlock® Original Insert Lens-

- Remove the shield from the helmet.
- Remove the Pinlock® Original Insert Lens from the eccentric pins with flexing the shield.(Fig.6)

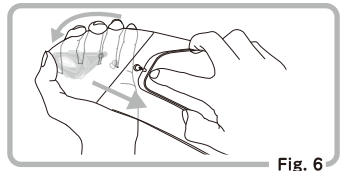

Fig. 6

-How to Adjust Pinlock® Original Insert Lens after attached it to the shield-

Adjust the Pinlock® Original Insert Lens if there is any space between the lens and the shield.

- Remove the shield from the helmet and detach the Pinlock® Original Insert lens from the shield.
- Adjust the eccentric pins by turning them with a tool. (Fig. 7)
- Fit the Pinlock® Original Insert Lens back on the shield. Make sure the Pinlock® Original Insert Lens and the shield do not have any space in-between after attaching the shield on the helmet. If there is any space please follow the same steps again.

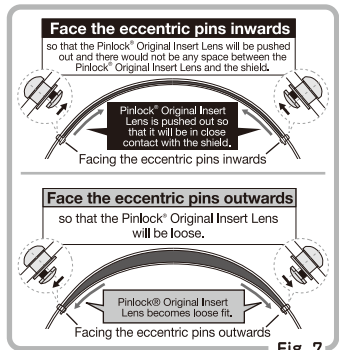

Fig. 7

* Please read carefully the **CAUTION** and the **CAUTION *Pinlock® Original Insert Lens** relevant to “Attaching/Detaching the Pinlock® Original Insert Lens” on the next page.

! CAUTION!

- Flex the shield properly when fitting the Pinlock® Original Insert Lens. Otherwise, eccentric pins may be damaged.
- Clean the inside of the shield before applying the Pinlock® Original Insert Lens. Pay attention not to touch the anti-fogging part of the silicon seal side.
- Do not use any petroleum products, thinner, glass cleaner, etc. It will degrade the material of the Pinlock® Original Insert Lens.
- Do not leave the Pinlock® Original Insert Lens where the temperature may surpass 50°C or near a heater, neither use a drier nor fire for drying. Heat may degrade the material of the Pinlock® Original Insert Lens.

! CAUTION! *Pinlock® Original Insert Lens

- Pinlock® Original Insert Lens is only for exclusive shields.
- If rain or water drops come in the space between the Pinlock® Original Insert Lens and the shield, please detach the Pinlock® Original Insert Lens from the shield and dry them out. Then, reattach the Pinlock® Original Insert Lens on the shield.
- Please detach the Pinlock® Original Insert Lens periodically for maintenance. Otherwise the silicon seal of the lens would adhere to the shield.
- Do not use any shields or pins other than exclusive ones for the Pinlock® Original Insert Lens.
- Please be aware that if you are riding with the ventilations closed or using the Wind Shutter, there may be a chance to cause the Pinlock® Original Insert Lens to become fogged.
- Please replace Pinlock® Original Insert Lens if the anti-fog performance decreases and/or being scratched.
- Silicon seal may come into view depending on the riding position.

8 Opening and Closing the Inner Sunshade

This helmet is equipped with the Inner Sunshade which protects your eyes from glare in day time. Available to open and close according to your needs.

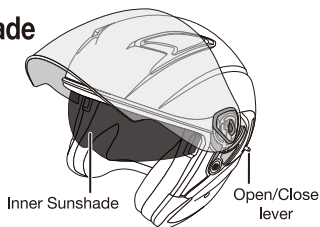

Continues to next page (P-17)



-Open/Close the Inner Sunshade-

To Open

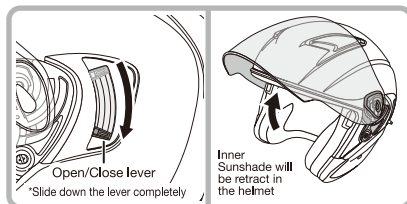

By sliding down the lever, Inner Sunshade will be retracted in the helmet.

To Close

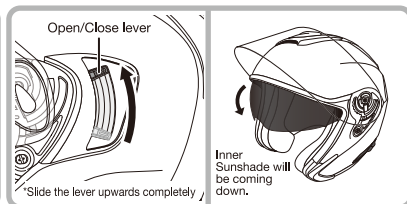

By sliding up the lever, Inner Sunshade will be coming down.

⚠️ **WARNING: About Open/Close Lever**

To open the Inner Sunshade, slide down the lever completely. Using the helmet with the lever in the middle of the part will cause the inner sunshade comes down by the vibrational and by another factors.

❗ **CAUTION!**



Do not operate the Inner Sunshade by holding it directly with your hand. Otherwise the Inner Sunshade may be damaged. Operate it with the Open/Close lever.

⚠️ **WARNING!**

- Open the Inner Sunshade during night rides or in a tunnel or such dark places.
- Open the Inner Sunshade when expecting change in temperature such as sudden rain, right after entering a tunnel or a place with a large height difference. In those situations, the Inner Sunshade can be fogged suddenly because of the difference in temperature in-and-outside the helmet.

❗ **If Open/Close Lever is Broken**

In case the open/close lever is broken, please contact authorized Kabuto dealers for repair about detailed information. (please refer to the page 24-25). Please understand there may be a case your order of repairing cannot be accepted if judged that the safety performance of the helmet cannot be assured by repairing.

9 Removing and Replacing the Inner Sunshade

–Detaching the Inner Sunshade–

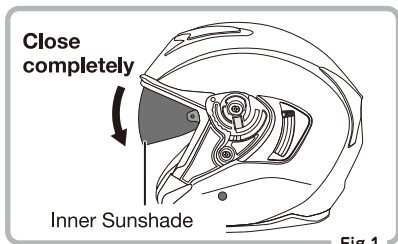
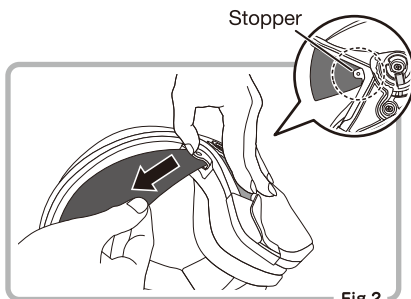
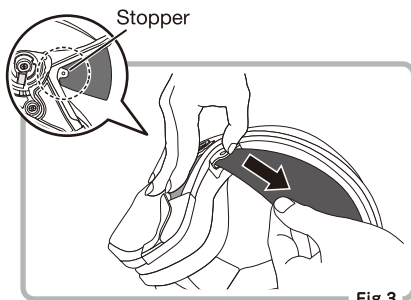

Fig.1

- ① Close the Inner Sunshade completely.



- ② By pulling up the stopper at the attachment part, pull out the inner sunshade to detach the side.



- ③ By pulling the other side of the inner sunshade in the same procedure explained in ②, the inner sunshade will be completely detached from the helmet.

! CAUTION!

Please make sure to follow the procedure explained in this instruction manual to detach the inner sunshade. Pulling it out forcibly or trying to detach by other procedures may cause the damage to the inner sunshade and/or the other part of the helmet.

–Attaching the Inner Sunshade–

- ① Make sure the lever is at the top position. (Inner sunshade is completely closed status).

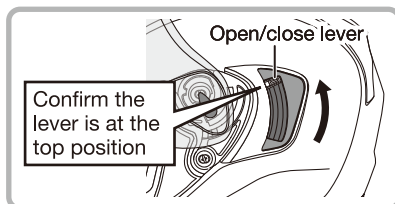

Continues to next page (P-19)

- ② Push the end of the Inner sunshade in the attachment, and make sure the projection is inserted into the attachment hole.

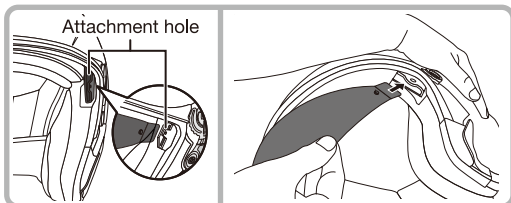

- ③ Repeat the same procedure on the other side of the inner sunshade to complete the attachment of the inner sunshade.

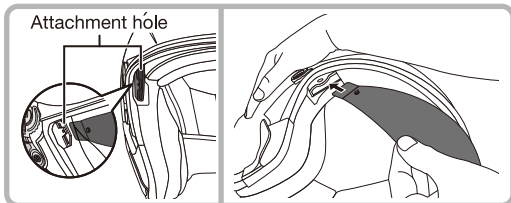

⚠ CAUTION!

After completed attaching the inner sunshade, try open and close the inner sunshade three to four times and confirm if there are no problem opening and closing movement. If any problem on opening and closing movement or any strange sounds found, please review the procedure written in this manual one more time, and re-attach the inner sunshade.

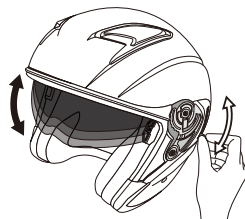

10 Removing and Replacing the Cheek Pad set

–Detaching the Cheek Pads–

- ① Undo the three snaps on the back side of the cheek pads. (Fig.1)
 ② Grip the center of the cheek pad firmly, and pull the pad to detach. (Fig.2)

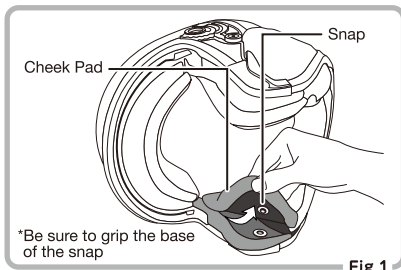

Fig.1

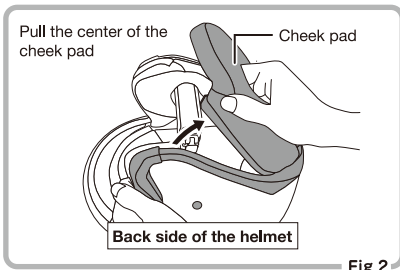

Fig.2

Continues to next page (P-20)



! CAUTION!

When undoing the snaps on the cheek pad, be sure to grip the base of the snap. Removing by gripping the cheek pad far from the snaps may cause the damage to the part.

Reference Ear Cups

You can find the ear cups under the cheek pads on the helmet shell side. Ear cups are attached by hook-and-loops fasteners. Depending on your needs, these ear cups are detachable.

*Ear cups are the common parts on the right and the left.

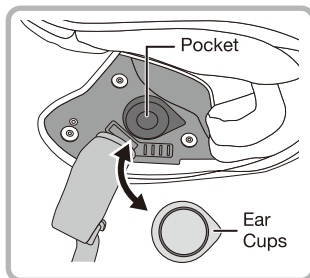

Reference Intercom System Attachment Space

A slit for attaching an intercom or a camera is installed in advance under the Cheek pad.

*For attaching an intercom or a camera, please follow the instruction manual given by the manufacture of those items.

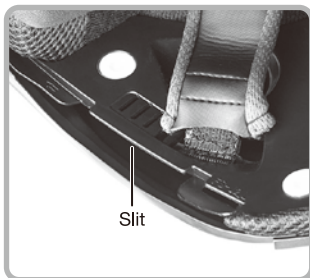

-Attaching the Cheek pads-

- ① Find the allow  mark as a guide, put the edge of the cheek pad interlining in the insert part.(you can find the insert part by flipping the rubber trim)
- ② ③ Push in the interlining in order along the rail part.
- ④ Snap the three snaps. Do the same procedure on the other side. (Fig.4)

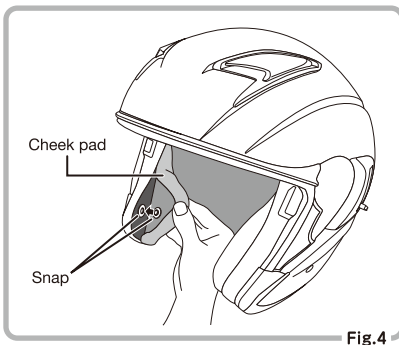
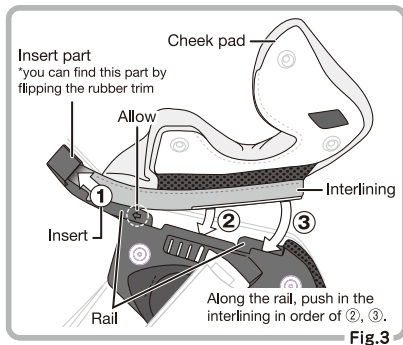

! CAUTION!

For the better fitting, attach the linings correctly.

11 Removing and Replacing the Inner Pad

-Removing the Inner Pad-

- 1 Remove the snaps on the forehead area from the helmet by pulling down. (Fig.1)
- 2 Undo the two snaps at the rear side of the helmet, then inner pad is completely removed. (Fig.2)

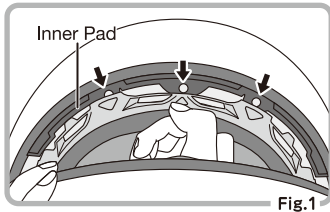

Fig.1

! CAUTION!

Do not remove the snaps and interlinings forcibly. Pull them out slowly and gently. Otherwise the linings and other parts may be damaged.

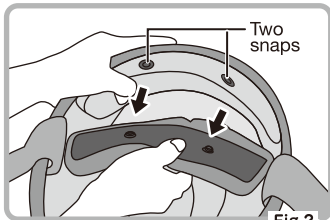

Fig.2

-Attaching the Inner pad-

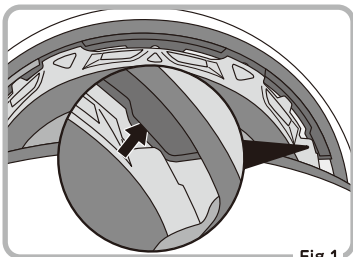

Fig.1

- 1 First, insert the interlining of the forehead part into the helmet side.

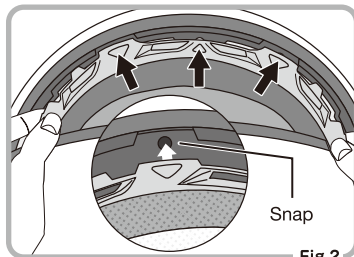

Fig.2

- 2 Second, push in each of three snaps to the helmet side as Fig.2.

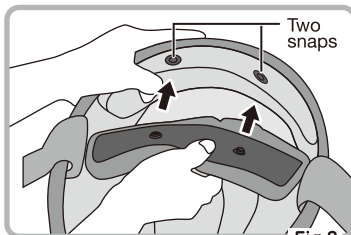

Fig.3

- 3 Lastly, complete the attachment by snap the two snaps on the rear part.

! CAUTION!

- Be certain to do snaps. It is very dangerous to ride with the snaps loosen.
- For better fitting, attach the linings correctly.

Reference Compatibility of the Inner Pad and the Cheek Pad set

EXCEED interiors are exchangeable as shown in the below table.

Allows fine fitting with your original combinations.

EXCEED Inner Pad

	Shell size	Helmet size	Pad thickness (default)	Compatibility	Inclusion
	M	XS	15mm	Compatible among XS and S	Inner pad x 1
S		9mm			
L	M	18mm	Compatible between M and XL		
	L	12mm			
	XL	9mm			

EXCEED Cheek Pad set

	Shell size	Helmet size	Pad thickness (default)	Compatibility	Inclusion
	M	XS	35mm	Compatible among all sizes	Cheek pad set (R+L) x 1
		S	30mm		
	L	M	35mm		
		L	30mm		
XL		25mm			

EXCEED Chinstrap Covers set

	Compatibility	Inclusion
	Exchangeable among all sizes	Chin strap cover (R/L) x1set

IMPORTANT

Notes about Cleaning Interior (Inner Pad, Cheek Pads and Chinstrap covers)

- The interiors of this helmet are all washable by a washing machine. Put each pad in a washing net and wash them separately.
- Use cleaning detergent in water or warm water. Never use hot water, chemical detergents, and organic solvents. These agents may degrade the quality and damage the pads.
- Even commercially-available detergent may cause a little discolouration of the pad depending on the type of detergent. Thus, please wash each pad separately as much as practical.
- If the pad is washed in a laundry having a drying function in which the temperature is increased to 50°C or more, it may cause deterioration in quality and damage of the pads. Do not use such a equipment for cleaning of the pad.
- Drain a pad after washing and dry the pad in shade so that it is not exposed to direct sunlight. After making sure that it is dried enough, attach it on the helmet.
- The interiors are consumable items. Even under normal usage, the fabric material and inner foam may be worn and deteriorated depending on the frequency of usage. Please replace the pads with new ones as appropriate.

Reference Functional Materials Adopted on EXCEED

COOLMAX®



COOLMAX® is used for the interior fabrics so as to allow quick evaporation of sweat and brings cool and comfortable use.

–Evaporate sweat quickly to achieve cool and comfortable use–

- When sweat comes out from the body, COOLMAX® allows discharging moisture to the outside and takes in air from the outside to cool and dry your body. As a result, the temperature on the body surface is lowered and exercise great moist adjustment accordingly.
- COOLMAX® provides a natural touch to the texture with soft and light weight and good permeability properties.

*COOLMAX® is the registered trade name of INVISTA.

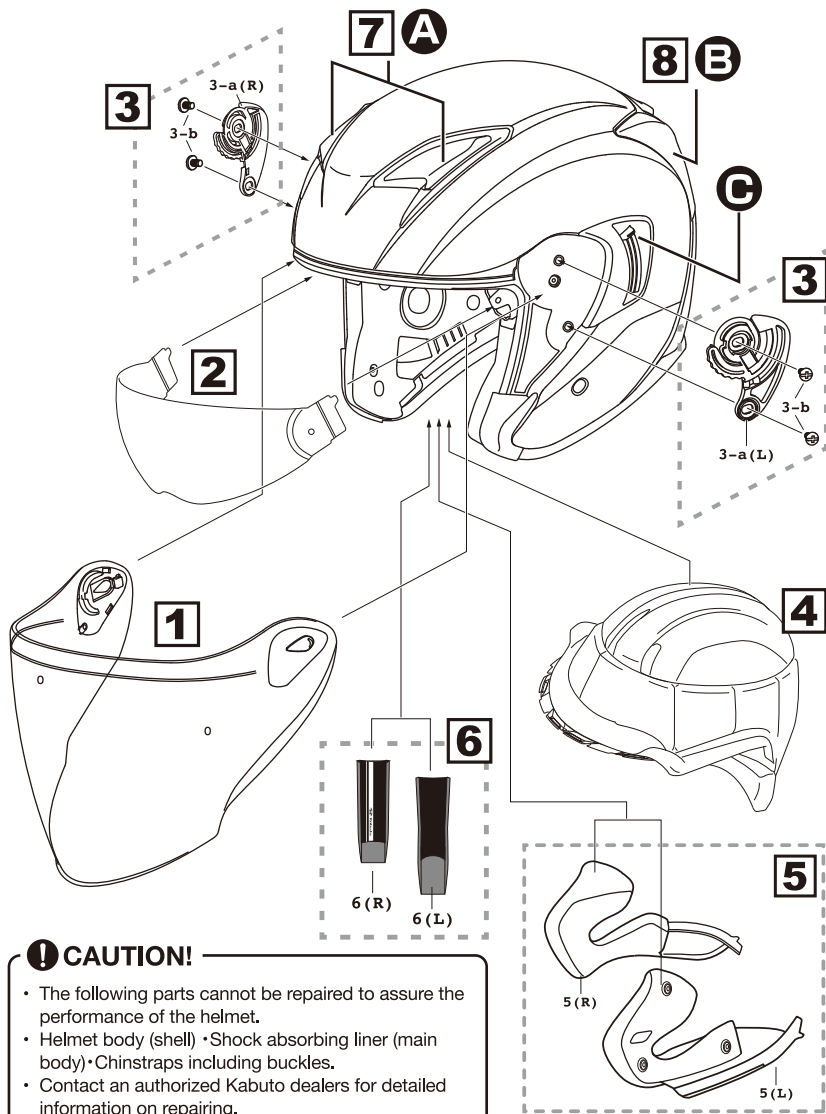
EXCEED Replacement Parts List • Repair • Contact



⚠ CAUTION!

- The following parts cannot be repaired to assure the performance of the helmet.
- Helmet body (shell) • Shock absorbing liner (main body) • Chinstraps including buckles.
- Contact an authorized Kabuto dealers for detailed information on repairing.

EXCEED Replacement Parts List

	Parts	Contains
①	SAJ-2 Shield	1: SAJ-2 shield (standard: clear)
②	CF-2 Inner Sunshade	2: CF-2 Inner sunshade (standard: smoke)
③	SAJ Shield Ratchet set	3-a: SAJ Shield Ratchet (R/L) x 1 ----- 3-b: 6x6 screw x 4
	6x6 Screw set	3-b: 6x6 screw x 4
④	EXCEED Inner Pad	4: *see page 22 (XS,S,M,L,XL,OPTION) Inner Pad x 1
⑤	EXCEED Cheek Pad Set	5: *see page 22 (XS,S,M,L,XL,OPTION) Cheek pad (R/L) x 1
⑥	EXCEED Chinstrap Covers set	6: *see page 22 (common in all sizes) Chinstrap cover set (R/L) x 1
⑦	EXCEED Head Ventilation	7: EXCEED Head Ventilation (each side, each color) x 1
⑧	EXCEED Rear Ventilation	8: EXCEED Rear Ventilation (each color), x 1
OPTION	SAJ-P Pinlock® Original Insert Lens	Option: SAJ-P Pinlock® Original Insert Lens

*Parts listed above are available from an authorized Kabuto dealer.

*For parts with color variations, please specify your desired color in your order.

*The materials and specifications are subject to change without prior notice for further improving the performance of the product.

*Please check our website for details about the parts.

EXCEED: Parts for Repair

These parts are repaired at cost of the user except damage attributable to a defect in material and workmanship of Kabuto helmets.

	Part name and Repair	Color/ Side	Remarks
Ⓐ	Head Ventilation	Each color/ Right or Left	Purchasable
Ⓑ	Rear Ventilation	Each color	Purchasable
Ⓒ	Inner Sunshade ·Open/close Lever	Common in all colors	Repair Only

Contact for Inquiries and Request of Repair

Request for Repair

Contact the authorized KABUTO dealer for request of repair.

*After inspected, there may be a case that your order of repairing cannot be accepted if it is judged that the safety performance of the helmet cannot be assured by repairing.

Parts that Cannot be Repaired

Following parts cannot be repaired in terms of assuring the performance of the helmet.

• Helmet body (shell) • Shock absorbing liner (main body, chin area) • Chinstraps including buckles

*Contact authorized Kabuto dealers for detailed information about repair and others.



Kabuto

Safety Meets Style

OGK KABUTO CO., LTD.

6-3-4, NAGATANISHI, HIGASHIOSAKA, OSAKA, 577-0016, JAPAN.

TEL:+81-6-6748-7806 FAX:+81-6-6747-8023

www.ogkkabuto.com