

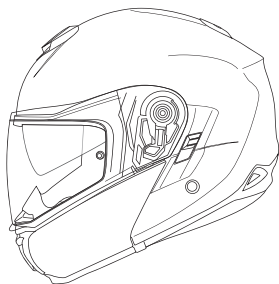

Kabuto

Japan

IBUKI



Instruction Manual

Manuel d'utilisation / Gebrauchsanweisung

Manuale d'istruzioni Indice / Manual de instrucciones

Handleiding / Bruksanvisning

Instrukcja obsługi / Instruktionsmanual

Εγχειρίδιο χρήσης / Manual de instruções

Käyttöopas / 日本語

IBUKI Instruction Manual / Table of Contents P-1

Helmet Description P-2

I. For Safe and Comfortable Use

Notes Before Use P-3

II. How to Use Functional Components

- 1** Fastening Chinstraps P-5
- 2** Open/Close Chin Cover P-6
- 3** Open/Close Inner Sunshade P-8
- 4** Open/Close Ventilations P-9
- 5** Pinlock® Original Insert Lens P-11

III. Maintenance

–Exterior–

- 6** Remove/Replace Shield P-14
- 7** Remove/Replace Inner Sunshade P-16
- 8** Remove/Replace Shield Ratchets P-18
- 9** Remove/Replace Chin Cover P-20

–Interior–

- 10** Remove/Replace Chinstrap covers P-21
 - 11** Remove/Replace Cheek Pads P-22
 - 12** Remove/Replace Inner Pad P-24
- NOTE** Exchangeable Inner Pad, Cheek Pads and Chinstrap covers P-25
- IMPORTANT** Cleaning of Inner Pad, Cheek Pads and Chinstrap covers P-25
- 13** Remove/Replace Wind Shutter P-26
 - 14** Remove/Replace Breath Guard-6 P-27

IV. Inquiries • Parts List • etc.

Cupro/ester composite and MOFF P-28

Contact for inquiries and request for repair P-28

IBUKI Parts List and Table for Replacement P-29

TEPUKA Helmet Description

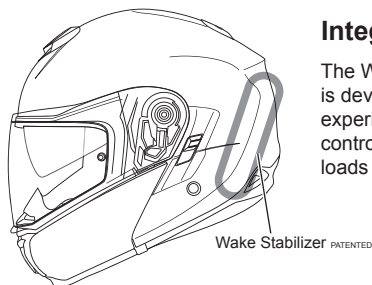
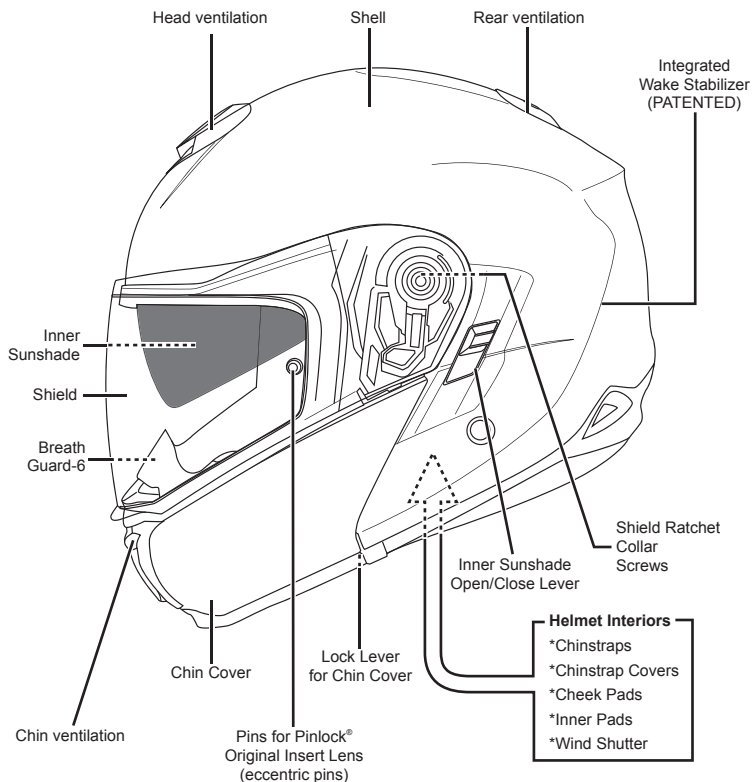

Integrated Wake Stabilizer PATENTED

The Wake Stabilizer PATENTED, Kabuto's unique system, is developed by analyzing the results of wind tunnel experiments at several angles. This unique system controls the airflow around the helmet and reduces loads while riding.

NOTES BEFORE USE

Thank you very much for purchasing a Kabuto helmet.

This Instruction Manual describes proper handling, various functions and remove/replace each part of this helmet. Please read this Instruction Manual thoroughly prior to use. After reading this, keep the Manual for future reference. The helmet is just one element of protection, it is intended to minimize the risk in the event of an accident. It cannot ensure complete safety. Use this helmet properly based on this understanding.

Please understand and follow the instructions and information in this Instruction Manual to enjoy your safe ride.

Select the proper size!

It is very dangerous to wear too large sized helmet. This may wobble while riding. If you wear a too small size helmet, it tightens up and hurts your head. Thus, it is important to select the proper size.

Fasten the chinstraps before riding

The helmet is designed to be retained by straps under the chin. In order to assure proper protection, the helmet should fit your head. When worn, adjust it to rest properly on the head, securely fasten the chinstraps to ensure safety. The chinstraps prevent the helmet from coming off in most cases.

Never use the helmet once impacted

Liners are essential for the intended performance of the helmet. This helmet has been designed to absorb the impact energy when components as shell and liners are partially destroyed by an impact. Even if visually no damage is apparent, it could be seriously damaged by a small impact. Regardless of the degree of damage, the helmet that underwent an impact or was abused even only once should not be used anymore. Always handle the helmet with care and make sure that no one sits on it or drops it.

Never modify the helmet

In order to fully maintain the performance of this helmet, do not attempt to take apart or change the helmet in any manner such as making holes in it, cutting it, scraping off the protective liner, or modifying the straps.

Helmet care and cleaning

Clean the helmet with soft cloth, using common ph-neutral detergent diluted with clear water. The cloth should not be soaking wet. Then wipe the helmet gently with a clean wet soft cloth and leave it to dry completely, but not in direct sunlight. With regard to helmets with removable interiors, carefully read the instruction manual for that model before attempting to remove the interiors and carry out cleaning according to the explanation provided. To clean the helmet, do not use saline water or hot water (above 50°C).

Do not paint or apply solvent

Any paint, glue, adhesive stickers, etc. (or the use of detergents and solvents other than those prescribed) may not only reduce the original protective performance of the helmet considerably, but may also cause damage to the helmet that cannot be detected by the naked eye.

Handle your helmet with care

Do not toss your helmet over a floor or sit on it. The helmet absorbs an impact every time it is handled roughly and its impact-absorbing capacity will be decreased. Handle your helmet with care to assure its full intended function in the event of an accident. Do not use your helmet for any purpose other than to use for protecting your head while riding.

The storage of the helmet

After using the helmet, stow it away in the helmet bag and store on a level place such as a shelf; the helmet may be damaged if it rolls around or falls down. Do not leave the helmet in direct heat above 50°C e.g. next to a heater or under direct sunlight in a car.

Shield care and cleaning

After using your helmet, with a wet soft cloth, lightly wipe off any grime (e.g. dead insects, dirt, sand, dust, etc.) on the shield and then fully wipe it clean using a dry soft cloth. When the shield gets wet (e.g. rainwater), it should always be wiped with a soft cloth after use. When cleaning the shield, never use any petroleum-based solvents or detergents containing abrasives. Contact with petroleum products and other solvents may impair the optical properties and reduce the mechanical strength. To clean the shield, apply some common ph-neutral detergent diluted with clear water using a soft cloth and wipe gently. Finally, wipe it dry with a lint-free soft cloth. To clean the shield, do not use saline water or hot water (above 50°C).

Cautions for shield

If the visor is marked "Day Time Use Only", visibility is limited to daylight conditions and it is not suitable for use at night. Tinted lenses are not suitable for use at night. A visor and goggles with scratches lowers the visibility and this is very dangerous. Such visors should never be used at night and should be replaced. Contact with petroleum products and other solvents may impair the optical properties and weaken the strength of the visor. Never try to open and close nor remove the visor while riding.

Notes for use of full-face helmet

When you wear a full-face helmet, the temperature in the helmet is maintained nearly constant during riding but the surroundings are constantly changing since you are moving at a high speed. For this reason, in case of sudden rain, immediately after entering a tunnel or in a place with a large height difference, the shield can be fogged suddenly because of the difference in temperature in-and-outside the helmet. In case such a risk is expected, please use caution with adjusting the shield or slowing down your speed in advance.

Never open and close the shield nor adjust the ventilation shutter while riding since it is very dangerous. Adjust the shield before riding.

1 Fastening Chinstraps

Buckle makes it easy to take on and off your helmet.

Fastening

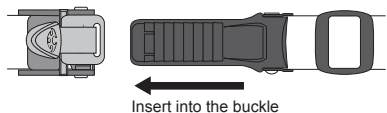

Unfastening

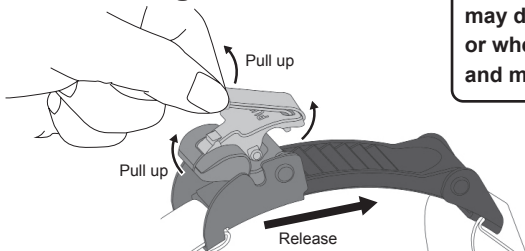

! WARNING!

Be sure to fasten the buckle securely before riding. If the buckle is not fastened or not fastened securely, your helmet may drop off in case of an accident or when falling down while riding and may cause serious injuries.

• Adjusting the chinstraps length

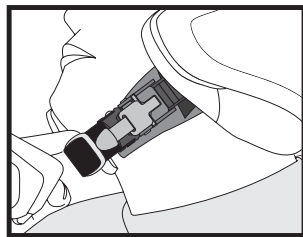
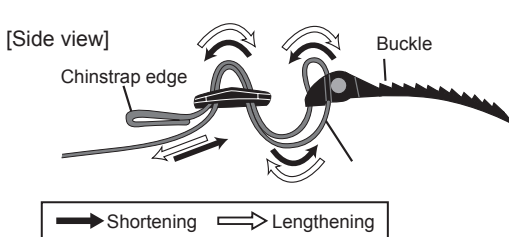

! WARNING!

Be sure to adjust the length of the chinstraps of the helmet properly. Otherwise, your helmet may drop off or choke your neck in case of an accident while riding. Chinstraps play a very important role. Thus please adjust the chinstraps of your helmet properly and securely before riding.

2 Open/Close Chin cover

This helmet adopts the system to open and close the chin cover.

[To Open the Chin Cover]

Pushing the lock lever on the Chin Cover as shown in the figure, open the Chin Cover up as far as it goes.

*Chin Cover only stops at fully opened or closing position.

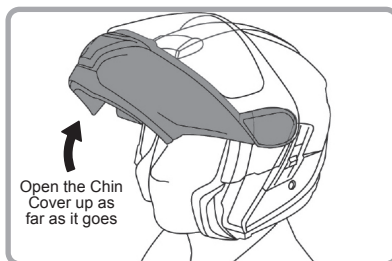
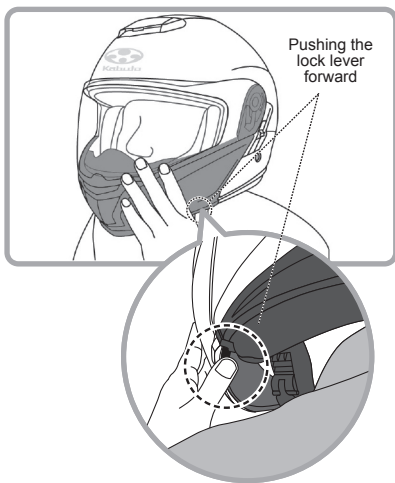

[To Close the Chin Cover]

Hold the Chin Cover as shown in the figure, and pull it down until you can hear the snap sound.

*Make sure to close firmly and locked.

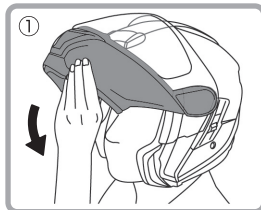

Continue to page 7



CAUTION!

- Please open the Chin Cover in a careful manner. Otherwise the attachment part and ratchet systems will break.
- Lock system adopted for firm closing. Please be careful not to shut the cover on your fingers or anything when you close the Chin Cover.

WARNING!

- Do not operate the Chin Cover while riding. It is very dangerous. Operate it before riding.
- Chin Cover only stops at fully opened or closing position. Never use the Chin Cover opened in any manner while riding. Please make sure you rides with closed position.
- It is very dangerous to ride with Chin Cover opened. The wind pressure on the Chin Cover will be big and it harm your neck or leads to a serious accident.
- Make sure to check and tighten the Collar Screw regularly. Riding with the loosen screws is very dangerous as the shield may be removed while riding, and it may leads to the serious accident.

3 Open/Close Inner Sunshade

This helmet is equipped with the Inner Sunshade which protects your eyes from glare in day time. This can be open/close according to your needs.

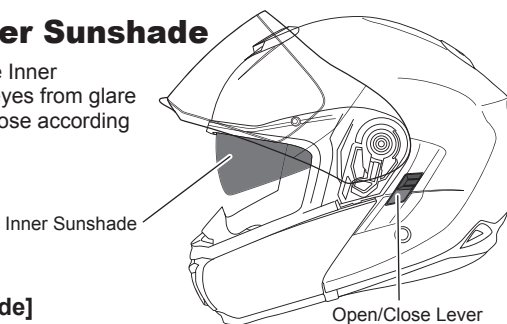

[Open/Close Inner Sunshade]

To Open

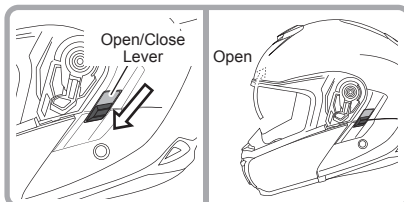

Slide the lever downwards to open the Inner Sunshade.

To Close

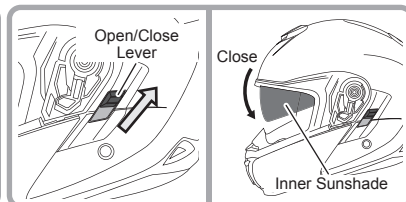

Slide the lever upwards to close the Inner Sunshade.

! CAUTION!

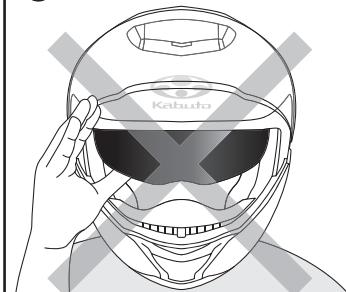

Do not operate the Inner Sunshade by holding it directly with your hand, otherwise the Inner Sunshade may be damaged. Operate it with the Open/Close lever.

! WARNING!

- Open the Inner Sunshade during night rides or in a tunnel.
- Open the Inner Sunshade when expecting change in temperature such as sudden rain, right after entering a tunnel or a place with a large height difference. In those situations, the Inner Sunshade can be fogged suddenly because of the difference in temperature in-and-outside the helmet.

! If Open/Close lever broke

In case the open/close lever broke, for repair please contact authorized Kabuto dealers for detailed information. (please refer page 28-30) Please understand there may be a case your order of repairing cannot be accepted if judged that the safety performance of the helmet cannot be assured by repairing.

4 Open/Close Ventilations

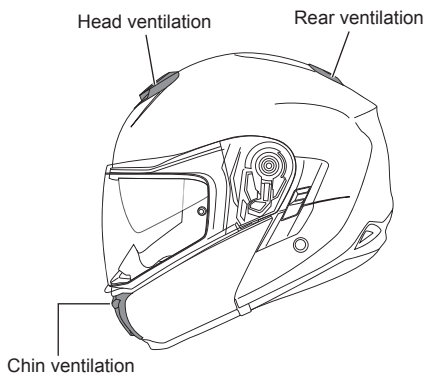

Ventilation System:

The ventilation system effectively takes outer air in and pushes the inner humid air out by the air pressure from the front while riding. The ventilations are equipped with a shutter which prevents cold air and water drops from coming into your helmet.

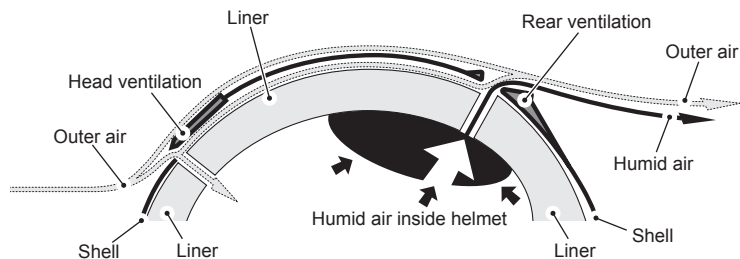

<IBUKI Ventilation system>

[Open/Close Head Ventilation]

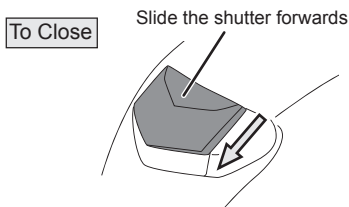
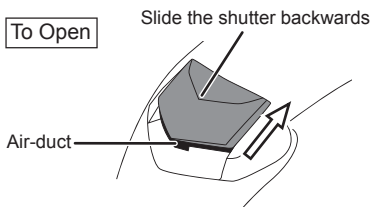

[Open/Close Chin Ventilation]

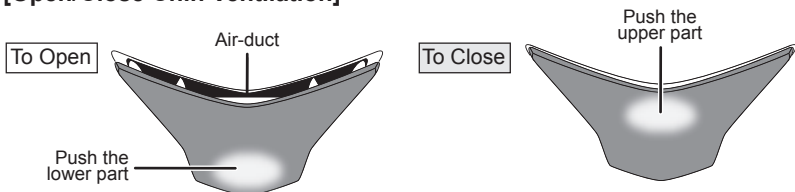

[Open/Close Rear Ventilation]

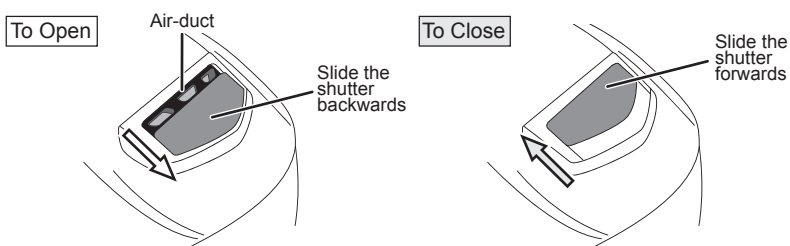

! CAUTION!

Do not put strong pressure on the ventilations.
Make sure to treat them with care.

! WARNING!

- Operating the shutter while riding is very dangerous. Never operate the shutter while riding. Operate it before riding.
- The air-ducts (air intakes and discharge holes) of the ventilations are designed in the proper sizes and quantities considered a large impact in the event of accidents and falling down. Customizing by enlarging or making more air-ducts would reduce the safety performances significantly and can cause serious injuries in case of an accident. Never customize your helmet.

! Repairing Ventilations

In case the ventilation is broken, either purchase the replacement and install it yourself, or have the authorized Kabuto dealer repair it. (please refer to page 28-30) Be noted that the authorized Kabuto dealer decline the repair work in case they judge safety, function of the helmet cannot be retained by the repair work.

5 Pinlock® Original Insert Lens



Pinlock® Original Insert Lens has international patent protection and is a registered brand name of Pinlock systems B.V. Further patents have been applied for.

[Pinlock® Original Insert Lens]

Pinlock® Original Insert Lens prevents the shield from fogging caused by thermal changes in winter or rainy weather etc.

Maintaining the proper space between the shield and the Pinlock® Original Insert Lens provides clear vision by balancing the inner and outer temperature.

[How to Fit the Pinlock® Original Insert Lens]

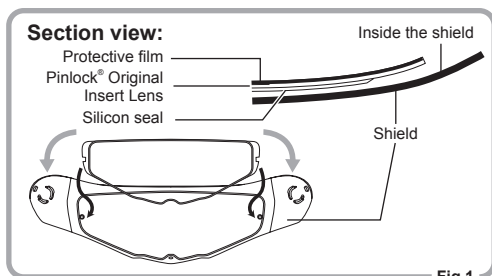

Fig.1

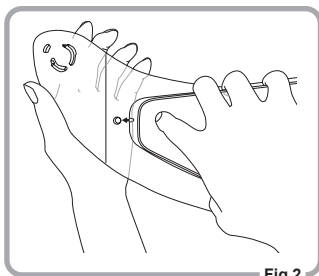

Fig.2

1. Apply the silicon seal side of the Pinlock® Original Insert Lens on inside the shield, without peeling off the protective film on the lens. At the time, apply the Pinlock® Original Insert Lens on inside the shield by clicking it into the eccentric pins. (Fig 1 and 2)

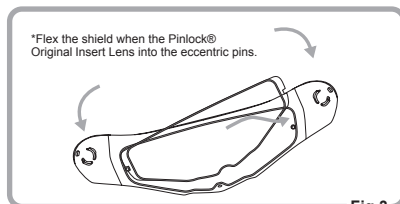

Fig.3

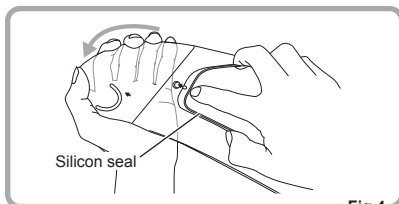
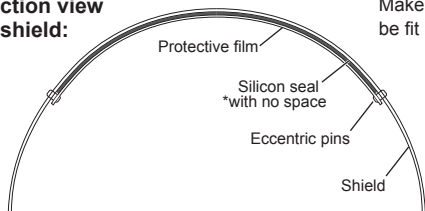
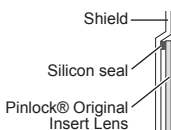
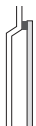

Fig.4

2. Flex the shield carefully until the shield becomes flat. Then, click the other side of the Pinlock® Original Insert Lens into the eccentric pins and then allow the shield to return carefully to its original curved shape. Make sure the Pinlock® Original Insert Lens to be fit inside the chase (Fig. 3, 4 and 5). (Follow 3 on next page)

Section view of shield:

Make sure the Pinlock® Original Insert Lens to be fit inside the chase.

Correct**Wrong****Fig.5**

3. Make sure if the overall silicon seal of the Pinlock® Original Insert Lens is attached firmly to the shield by mounting the shield on the helmet. If there is any space between them, refer to "How to Adjust Pinlock® Original Insert Lens after Attachment" and adjust the lens.

*Please mount the shield on the helmet when checking if the Pinlock® Original Insert Lens is attached firmly to the shield. Otherwise, the shield might be spread out by the pressure from the lens and it cannot be assured if the lens has attached on the shield firmly.

4. Peel off the protective film on the Pinlock® Original Insert Lens.

[How to Remove Pinlock® Original Insert Lens]

1. Remove the shield from the helmet.
2. Remove the Pinlock® Original Insert Lens from the eccentric pins with flexing the shield. (Fig.6)

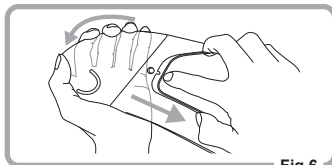
**Fig.6****[How to Adjust Pinlock® Original Insert Lens after Attachment]**

Adjust the Pinlock® Original Insert Lens if there is any space between the lens and the shield.

1. Remove the shield from the helmet and detach the Pinlock® Original Insert lens from the shield.
2. Adjust the eccentric pins by turning them with a tool. (Fig. 7)
3. Fit the Pinlock® Original Insert Lens back on the shield. Make sure the Pinlock® Original Insert Lens and the shield do not have any space in-between after attaching the shield on the helmet. If there is any space please follow the same steps again.

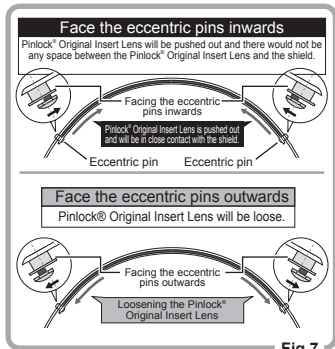
**Fig.7**

* Please read carefully the "CAUTION" and the "CAUTION *Pinlock® Original Insert Lens".

II. How to Use Functional Components

! CAUTION!

- Flex the shield properly when fitting the Pinlock® Original Insert Lens. Otherwise, eccentric pins may be damaged.
- Clean the inside of the shield before applying the Pinlock® Original Insert Lens. Pay attention not to touch the anti-fogging part of the silicon seal on the Pinlock® Original Insert Lens.
- Do not use any petroleum products, thinner, glass cleaner, etc. It will degrade the material of the Pinlock® Original Insert Lens.
- Do not leave the Pinlock® Original Insert Lens where the temperature may surpass 50°C or near a heater, neither use a drier nor fire for drying. Heat may degrade the material of the Pinlock® Original Insert Lens.

! CAUTION *Pinlock® Original Insert Lens

- Pinlock® Original Insert Lens is only for exclusive visors.
- If rain or water drops come in the space between the Pinlock® Original Insert Lens and the shield, please detach the Pinlock® Original Insert Lens from the shield and dry them out. Then, reattach the Pinlock® Original Insert Lens on the shield.
- Please remove the Pinlock® Original Insert Lens at times for maintenance. Otherwise the silicon seal of the lens would adhere to the shield.
- Do not use any shields or pins other than exclusive ones for the Pinlock® Original Insert Lens.
- Please be informed that if you are riding with the ventilations closed or using the Wind Shutter, may cause the Pinlock® Original Insert Lens to become fogged.
- Please replace Pinlock® Original Insert Lens if the anti-fog performance decreases and/or being scratched.
- Silicon seal may come into view depending on the riding position.

6 Remove/Replace Shield

[To Remove] *This explanation indicates the left side when the helmet is worn.

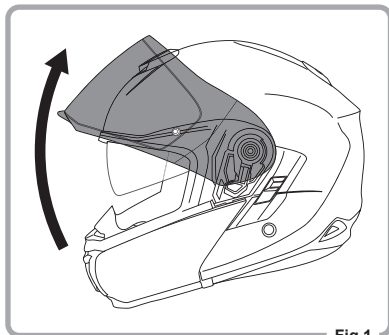

Fig.1

1. Open the shield as far as it goes.

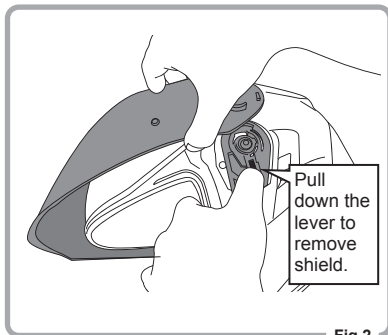

Fig.2

2. As pulling the lever on the ratchet downwards, pull out the shield downwards, so one side of the shield will be removed.

3. Repeat the same procedure for removing the other side of the shield.
Then the entire shield can be completely removed.

! CAUTION!

- Do not pull or twist the shield by force to remove it. Such action may damage the shield and ratchet system.
- Handle the removed shield with care in order not to damage it.

[To Install] * This explanation indicates the left side when the helmet is worn.

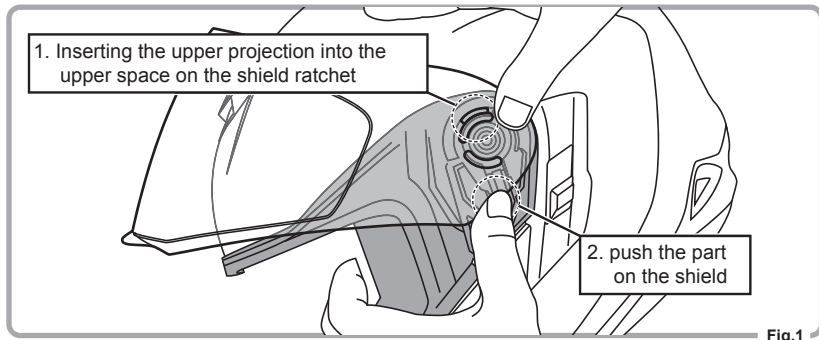

1. Inserting the upper projection into the upper space on the shield ratchet, push the part on the shield indicated on above figure, so on side of the shield will be installed.
2. Repeat the same procedure for removing the other side of the shield. After installation, open and close the shield some times to make sure that the shield works properly. If no problem, the shield installation is complete.

! CAUTION!

- Do not push or twist the shield by force when installing it. Such action may damage the shield and ratchet system.
- After installation, be sure to pull it lightly towards the removing direction to make sure that it is securely installed. Also open and close the shield some times to make sure that the shield works properly.

! WARNING!

- After the installation of the shield has done, make sure that the shield is securely installed and that it is properly opened and closed before riding. If the shield does not work properly, or is installed insecurely, it may cause a failure in opening and closing the shield or lead to the removal of the shield while riding, thereby causing a great risk. If the opening and closing operations are not properly performed or abnormal noise is heard during these operations, check the steps in the installation procedure and repeat the installation procedure from the start.
- The shield is a consumable item. If the shield surface is damaged by a bug, stone, etc., it may hinder the vision, thereby causing a great risk. If the shield gets extremely dirty or scratched, replace it with a new one.

7 Remove/Replace Inner Sunshade

[To remove Inner Sunshade]

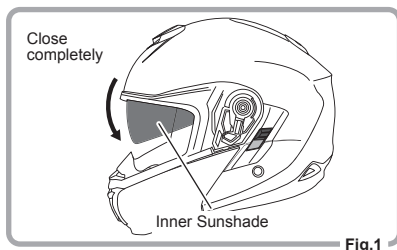

1. Close the Inner Sunshade completely.

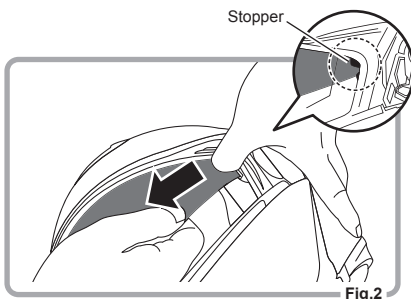

2. Pulling up the stopper at the attachment of the Inner Sunshade, pull out the Inner Sunshade in the direction of arrow.

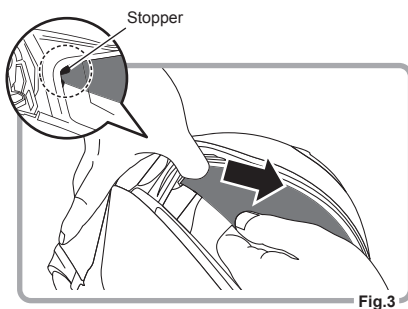

3. Follow the same procedure on the other side to remove the Inner Sunshade completely.

! CAUTION!

Follow the above procedure to remove the Inner Sunshade. Pulling the Inner Sunshade forcibly or removing it in any other way may damage the Inner Sunshade and/or any parts on the helmet.

[To Insert the Inner Sunshade]

1. Confirm the lever is at the top and Inner Sunshade is closed completely.

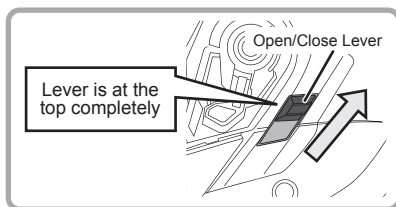

2. Push in the Inner Sunshade end to the attachment hole on the helmet until it knocks.

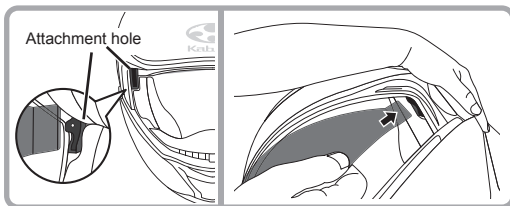

3. Set the other end securely into the hole.

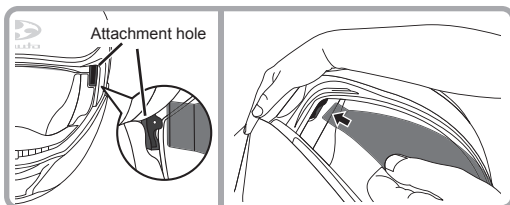

! CAUTION!

After attaching the Inner Sunshade, open/close it some times to check if the Inner Sunshade works properly.
If you hear abnormal noise and/or the Inner Sunshade cannot be opened/closed properly, please reattach it after reading the above procedure carefully.

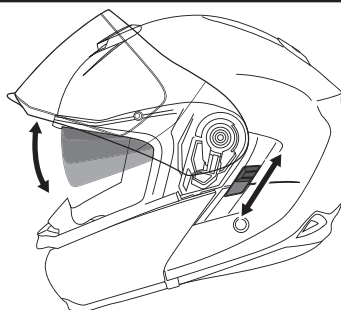

8 Remove/Replace Shield Ratchets

The "Shield Ratchet" is a part to control the function of open/close and detach/attach the shield. When the shield is completely removed in the procedure mentioned in **6 Remove/Replace Shield**, the Shield Ratchet appears.

[To Remove the Shield Ratchet]

*This explanation indicates the left side when the helmet is worn.

1. Remove the shield.
(ref. **6 Remove/Replace Shield**)
2. Turn the Collar Screw on the Shield Ratchet counterclockwise using a M4 (4mm) hex wrench and remove the Collar Screw and the collar. (Fig.1)
3. Remove the hook on lower side of the shield ratchet from the hole on the Chin Cover. (Fig.2)
4. Follow the same procedure to remove the Shield Ratchet on the other side.

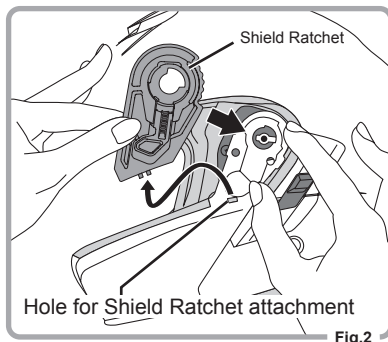
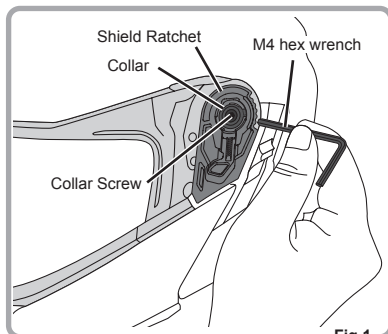

! CAUTION!

- Use the proper sized tool to remove the Collar Screws.
Turn the screw by applying the tool vertically to the screw. If the improper sized tool is used or the screw is turned diagonally, the threads may be stripped.
- Do not lose the removed screws.

[To Insert the Shield Ratchet] *This explanation indicates the left side when the helmet is worn.

1. Check the side of the Shield Ratchet (Fig.1)

*Collar has marks. On the right side with mark "R", and left side with "L".

2. Place the hook of the Shield Ratchet (L) in the hole on the left side of the Chin Cover and attach the collar (L).
3. Fasten Collar Screw clockwise using a M4 (4mm) hex wrench. Repeat the same procedure on the other Shield Ratchet.

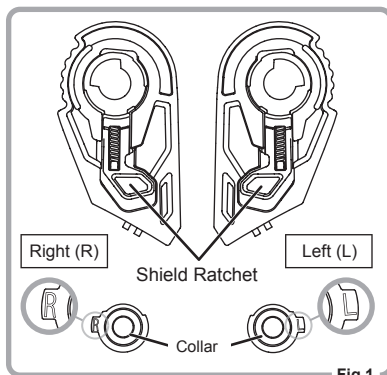

Fig.1

CAUTION!

- Do not fasten the Collar Screws too tight. Too much tightening of the screws may damage screws and other parts.
- Fasten the Collar Screws by applying the tool vertically to the screws. If the screws are fastened by applying a tool diagonally, the threads may be stripped.

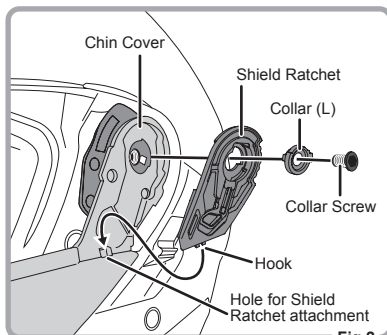

Fig.2

WARNING!

- The Shield Ratchet is an important part for open/close the shield. Install the Shield Ratchet securely. After the installation is completed, check to see that the shield can be closed to the lowest position and opened and closed correctly.
- Check and fasten the Collar Screws regularly. Riding with the loosened Shield Ratchet Screws is very dangerous as the shield may be removed while riding.

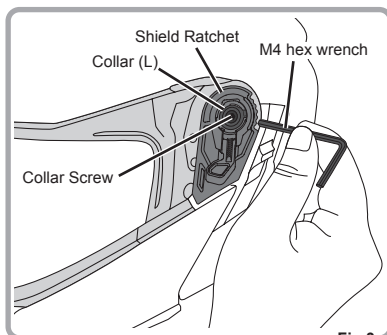

Fig.3

9 Remove/Replace Chin Cover

To maintain the Chin Cover, you can remove the Chin Cover.

[To Remove Chin Cover]

1. Remove the shield.
(Please check **6 Remove/Replace Shield**)
2. Remove Shield Ratchets and Collars.
(Please check **8 Remove/Replace Shield Ratchets**)
3. Place the helmet on the stable place, then unlocking the Chin Cover by pushing the lock lever forward and pull forward the Chin Cover. Then the Chin Cover completely removed.

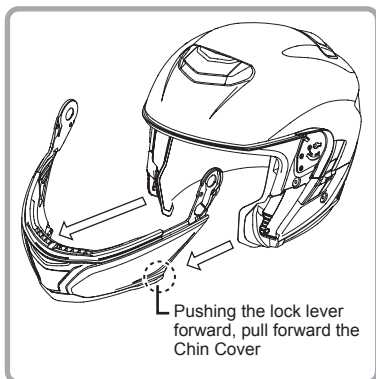

[To Install Chin Cover]

1. Lock the Chin Cover by inserting the Chin Cover to the helmet.
2. In reverse order of removing, attach both side Shield Ratchets and Collars with Collar Screws, then install the shield.
(Please check **8 Remove/Replace Shield Ratchets**, and **6 Remove/Replace Shield**)
3. Open and Close the Chin Cover some times, to check if they are all attached properly.



WARNING!

- Make sure to check the Chin Cover installed securely and moves properly before using the helmet for riding. If the installation of the Chin Cover is incomplete, it is very dangerous and may fall off while riding and may leads to a serious accident.
- Make sure to check and tighten the Collar Screw regularly. Riding with the loosen screws is very dangerous as the shield may be removed while riding, and it may leads to the serious accident.

10 Remove/Replace Chinstrap cover

Chinstrap Covers are removable and washable.

[To Detach]

1. Undo the snap at the end of each chinstrap.
2. Pull the chinstrap cover from the chinstrap to detach it,

[To Attach]

1. In the reverse order of detaching (pay attention to the direction of the chinstrap cover), let the chinstrap go through from the upper portion of the chinstrap cover:
2. Finally, fasten the snap.

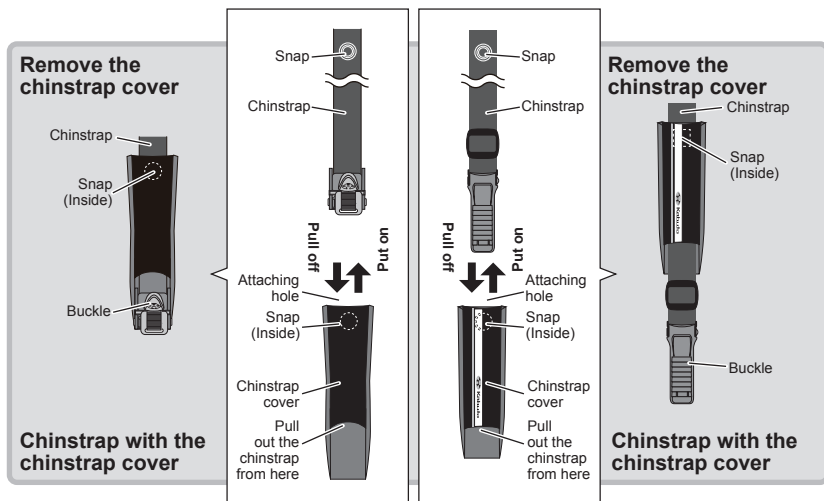

! CAUTION!

Please pay attention to the side of the chinstrap covers.

11 Remove/Replace Cheek pads

[To remove the cheek pads]

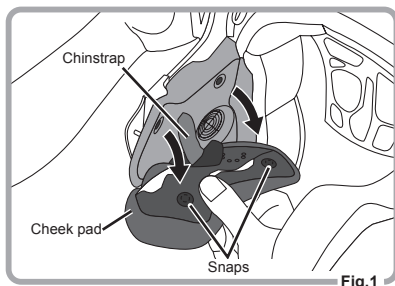

1. Remove the Cheek pads from 2 snaps on the back of the pads, and pull out the Chinstrap from the Cheek pads.

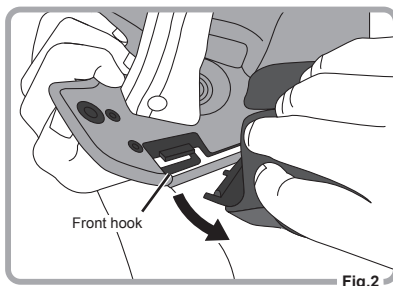

2. Pull out the front hook of the Cheek pads from the helmet.

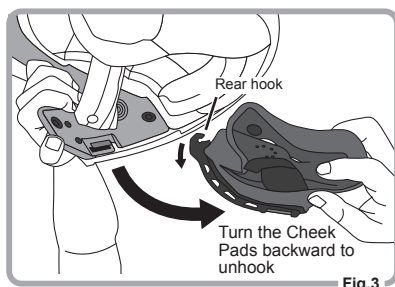

3. Turn the Cheek Pads backwards to unhook the Cheek pad.

Note Ear Cup

Ear Cup is set on the back side of the Cheek pad. This is removable according to your needs and fitting. Remove the Cheek pad to remove the Ear Cup.

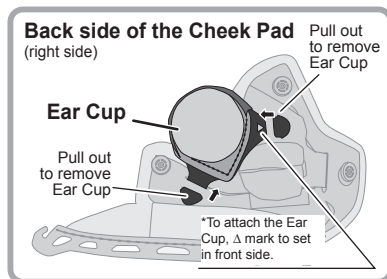

CAUTION!

When removing from snaps, make sure to hold the base of the snaps. Otherwise the snaps and Cheek Pads itself will break.

[To Install Cheek Pads]

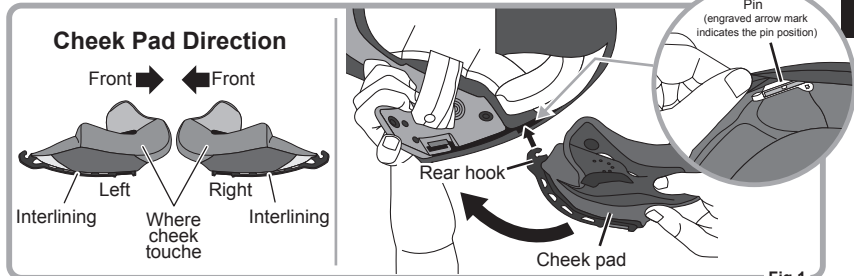

Fig.1

1. Check the sides of the Cheek Pads. Hook the rear hook of Cheek Pad on the pin inside the helmet. (Engraved arrow mark indicates the position of the pin inside the helmet).(Fig.1)
2. Push in the front hook of Cheek Pad to the mount on the helmet. (Fig.2)
3. Fasten securely the 2 snaps on the back of the Cheek Pads. And repeat the same procedure on the other Cheek Pad. (Fig.3)

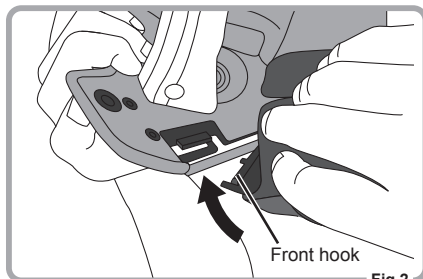

Fig.2

*After installation is complete, please smooth a wrinkles and sag of Chinstrap covers.

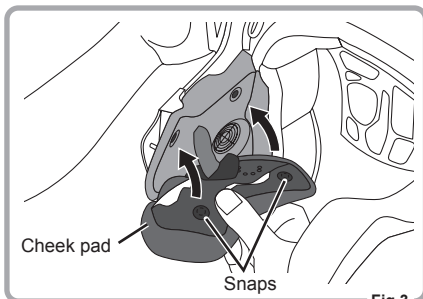

Fig.3

! CAUTION!

Be sure that the cheek pads are installed on the helmet securely before riding. It is hazardous to use this helmet without cheek pads or attaching the cheek pads improperly.

12 Remove/Replace Inner Pad

[To Remove Inner pad]

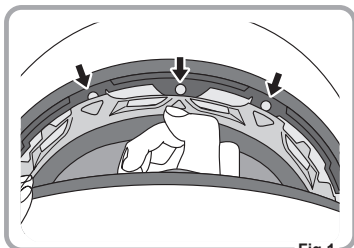

Fig.1

1. Undo the snaps at the forehead area by pulling them down. (Fig.1)

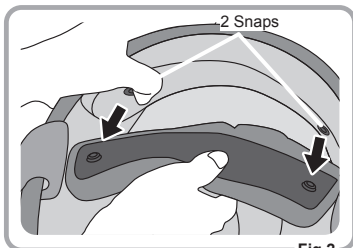

Fig.2

2. Undo the 2 snaps at the rear, then the inner pad will be removed. (Fig.2)

[To Install Inner pad]

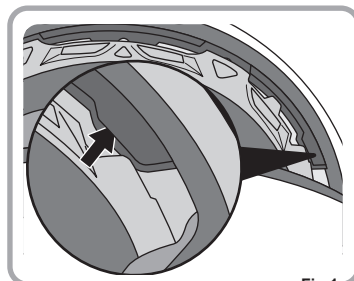

Fig.1

1. Insert the interlining at the temple areas.

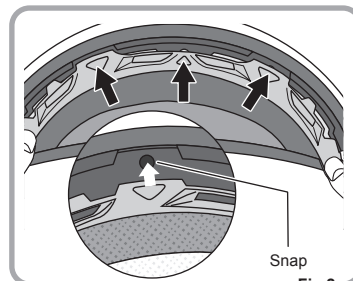

Fig.2

2. Insert the 3 snaps at the front.

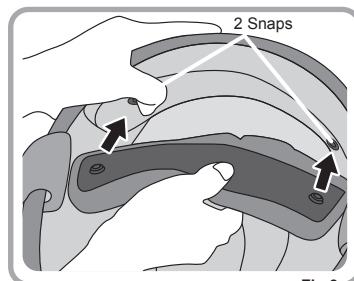

Fig.3

3. Fasten the 2 snaps at the rear to complete attaching the pad.

⚠ CAUTION!

- Pull the snaps gently to remove the inner pad. Otherwise the material and parts may damage.
- If the inner pad is not securely installed, the helmet may be unstable while riding, thereby causing a great risk. Fasten the snaps properly.

III. Maintenance –Interior–

Note Exchangeable Inner Pad, Cheek Pads and Chinstrap covers

IBUKI interiors are exchangeable as shown in the table below. Fine fitting can be achieved by changing only cheek pads etc.

IBUKI Inner pad

	Shell size	Pad size (Thickness)	Exchangeable	Included in package
	M	XS (19mm)	Interchangeable among the sizes of XS, S and M	Inner pad x 1pce
S (15mm)				
M (9mm)				
L	L (12mm)	Interchangeable among the sizes of L, XL and XXL	Inner pad x 1pce	
	XL (9mm)			
	XXL(16mm)			

IBUKI Cheek pad

	Shell size	Pad size (Thickness)	Exchangeable	Included in package
	M	XS (37mm)	Exchangeable among all sizes	Cheek pad x 1set (right and left)
S (33mm)				
M (24mm)				
L	L (29mm)			
	XL (20mm)			
	XXL(16mm)			

IBUKI Chinstrap cover

	Exchangeable	Included in package
	Exchangeable among all sizes	Chin strap cover x 1set (right and left)

IMPORTANT Cleaning of Inner Pad, Cheek Pads and Chinstrap covers

- The interiors of this helmet are washable by a washing machine. Put each pad in a washing net and wash them separately.
- Use detergent in cold or warm water for cleaning. Never use hot water, chemical detergents, and organic solvents for cleaning the pads. The use of these agents may degrade the quality and damage the pads.
- Even commercially-available detergent may cause a little discoloration of the pad depending on the type of detergent. Thus, please wash each pad separately as much as practical.
- If the pad is washed in a washing machine with a drying function in which the temperature is increased to 50°C or more, it may cause deterioration in quality and damage of the pads. Do not use such a device for cleaning of the pad.
- Drain a pad after washing and dry the pad in shade so that it is not exposed to direct sunlight. After making sure that it is dried enough, attach it on the helmet.
- The inner pad and the cheek pad are consumable items. Even under normal usage, the fabric material and inner foam may be worn and deteriorated depending on the frequency of usage. Please replace the pads with new ones as appropriate.

13 Remove/Replace Wind Shutter

The Wind Shutter is included in the package as the standard accessory. This accessory is intended to reduce the introduction of wind from chin area while riding. It can be attached and detached as desired according to seasons and intended applications.

[To Remove Wind Shutter]

Firmly hold the whole interlining area of the Wind Shutter and push it on the direction of the arrow on the figure. Then the hooks on the Wind Shutter will be removed.

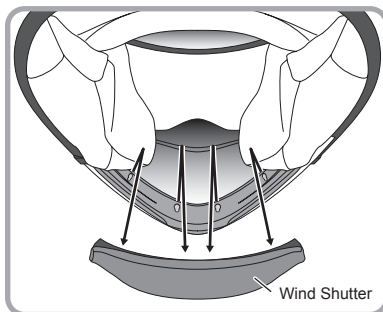
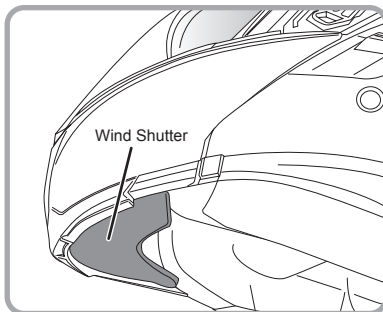

! CAUTION!

Make sure to hold the whole interlining area of the Wind Shutter to remove. Do not forcibly pull out. The parts may break.

[To Attach Wind Shutter]

1. Check Fig.1 and make sure the side (inner side or outer side).
2. Check Fig.2. Push in the hook on the Wind Shutter into the holes inside the Chin Cover. Follow the arrow direction to push in hooks.

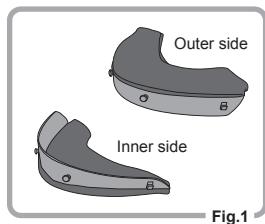

Fig.1

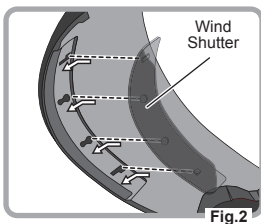

Fig.2

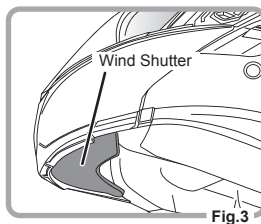

Fig.3

! CAUTION!

Make sure to install the Wind Shutter securely. Insecure installation may cause falling of the Wind Shutter while riding.

14 Remove/Replace Breath Guard-6

The Breath Guard-6 may be detached or attached according to your needs.

[To Remove Breath Guard-6]

Grip the Breath Guard-6 securely, and pull it upward to remove it.

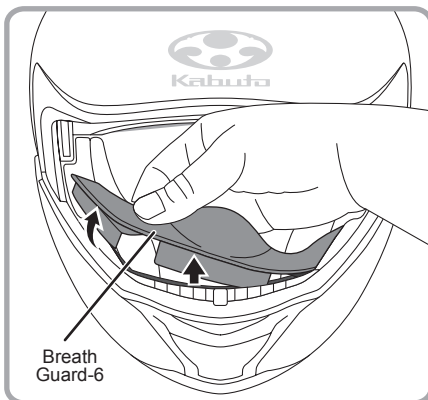

[To Install Breath Guard-6]

As shown in the figure, set the each sleeve of the Breath Guard-6 into each slit on the helmet.

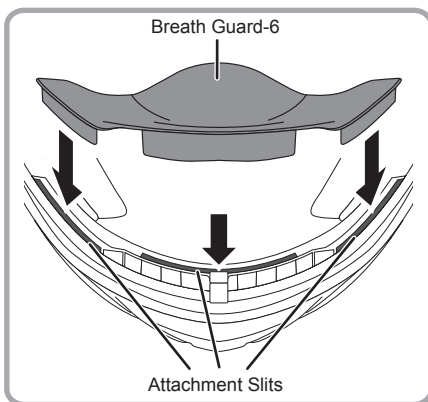
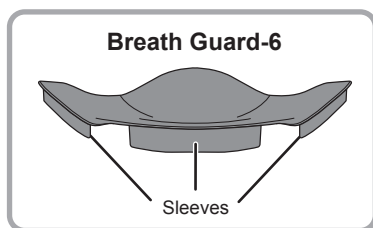

! CAUTION!

Do not use an adhesive agent but follow the procedure given above to attach the Breath Guard-6. Some components of an adhesive agent may damage the material of the helmet.

Cupro/ester composite high-function fibre

High-function fiber with material specially composited with cupro and functional polyester, offers superior cooling performance, quick moisture absorption and desorption, and UV protection.

**MOFF instant deodorizing fiber**

The IBUKI's Chinstrap uses a new deodorant fiber called MOFF, developed with nanotechnology, which employs a new odor elimination method never done before.

MOFF is the next-generation deodorizing fiber with an environment-friendly nature as well as instant odor elimination and safety characteristics.

[How to clean the Chinstrap]

To keep the effectiveness of MOFF material, gently wash the chinstrap with cool or warm water (below 35°C, 95°F.) Towel dry and place it in a shaded and ventilated area.

When using a cleanser, use mild soap. (Do not use alkaline or similar detergent.)

Contact for inquiries on the products and request for repair

Contact an authorized dealer of Kabuto helmets about the products and request for repair.

Request for repair

- Contact the authorized Kabuto dealers for request of repair.
- Before sending back the helmet to us, contact the following address for detailed information and report on repair in advance. Without prior information and report, there may be a case that quick action for repair cannot be taken.

*After we received an article to be repaired, there may be a case that we cannot accept your order for repairing if it is judged that the safety performance of the helmet cannot be assured by repairing.

Parts that cannot be repaired

The following parts cannot be repaired in terms of assuring the performance of the helmet.

- **Helmet body (Shell)**
- **Shock absorbing liner (Main body, chin area)**
- **Chinstraps including Buckles**

Contact authorized Kabuto dealers for detailed information on repair and others.

•IBUKI Parts List and Table for Replacement

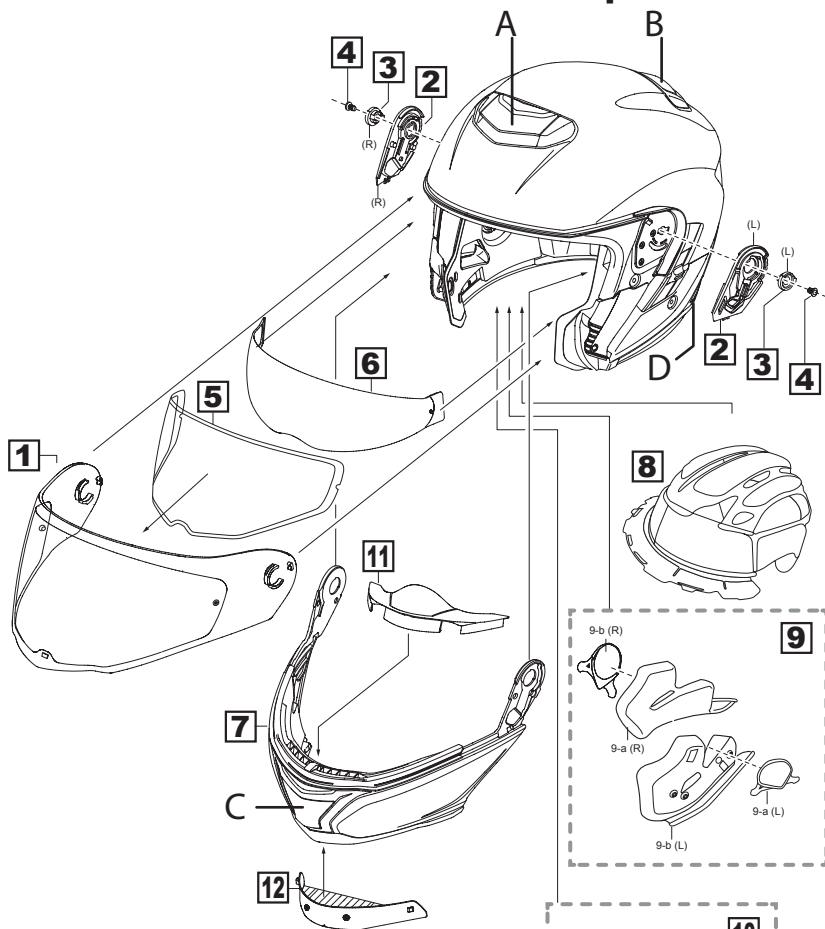

⚠ CAUTION!

The following parts cannot be repaired to assure the performance of the helmet. •Helmet body (shell)
 •Shock absorbing liner •Chinstraps including Buckles
 Contact the authorized Kabuto dealers for detailed information on repairing.

•IBUKI Parts for Replacement

No.	Shell size	Contains
1	CM-1-P Shield	CM-1-P Shield (standard: clear) x 1
2	CM-1 Shield Ratchet Set	CM-1 Shield Ratchets(L/R) x 1
3	CM-1 Collar Set	CM-1 Collar (L/R) x1
4	CM-1 Collar Screw set	CM-1 Collar Screw x2
5	CM-1-P Pinlock® Original Inesert Lens	CM-1-P Pinlock® Original Inesert Lens x 1
6	CM-1 Inner Sunshade	CM-1 Inner Sunshade (standard:smoke) x 1
7	IBUKI Chin Cover	IBUKI Chin Cover x 1
8	IBUKI Inner Pad	*see page25 (XS, S, M, L, XL, XXL)Inner Pad x 1
9	IBUKI Cheek Pad set	9-a: see page 25 (XS, S, M, L, XL, XXL) Cheek Pad (L/R) x1
	IBUKI Ear Cup	9-b: IBUKI Ear Cup (L/R) x1 9-b: IBUKI Ear Cup (L/R) x1
10	IBUKI Chinstrap Cover Set	IBUKI Chinstrap Cover (L/R) x 1
11	Breath Guard-6	Breath Gurad-6 x 1
12	IBUKI Wind Shutter	IBUKI Wind Shutter x 1

*The parts listed above are available from an authorized KABUTO dealer.

*Parts with colour variations, specify your desired colour in placing an order.

*The materials and specifications are subjected to change without notice for further improving the performance of the product.

*Check out our website for details about the parts. <http://www.ogkkabuto.com>

•IBUKI Parts for Repair

*These parts are repaired at cost of the user except damage attributable to a defect in material and workmanship of Kabuto helmets.

	Part name and Repairs	Colour/Side	Remarks
A	Head Ventilation	Each Colour	Purchasable
B	Rear Ventilation	Each Colour	Purchasable
C	Chin Ventilation	Each Colour	
D	Inner Sunshade, Open/Close Lever	Common in all colours	

*Refer to page 28 for more information on repairing.



OGK KABUTO CO., LTD.
6-3-4, NAGATANISHI, HIGASHIOSAKA, OSAKA, 577-0016, JAPAN.
TEL:+81-6-6748-7806 FAX:+81-6-6747-8023
www.ogkkabuto.com